

HULALA

H O M E

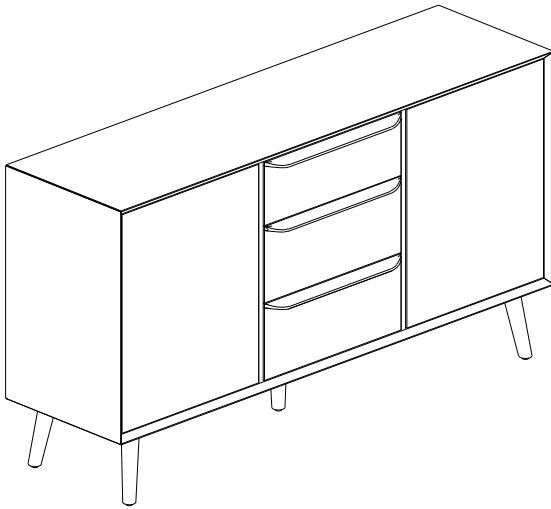

ITEM NO.TVHM0713

NOTE:

This brochure contains IMPORTANT safty info. Please read and keep for future reference.

MAINTAINANCE AND WARNING

- Keep furniture away from heat sources.
- Do not clean furniture with harsh cleaner or polishes. Do not use detergents, Solvents, abrasives, spray packs or leather cleaner. Use non-color mild soap with warm water to clean spills (Mix 1:10 soap to water)
- Do not place furniture under direct sunlight, material will possibly fade over time.
- Do not use on site dry Cleaning machine. Children should not climb or jump on the furniture.
- Do not write on furniture that is not protected by a padded barrier .
- Not for commercial use, only for residential use.



Weight Limitation

150LBS

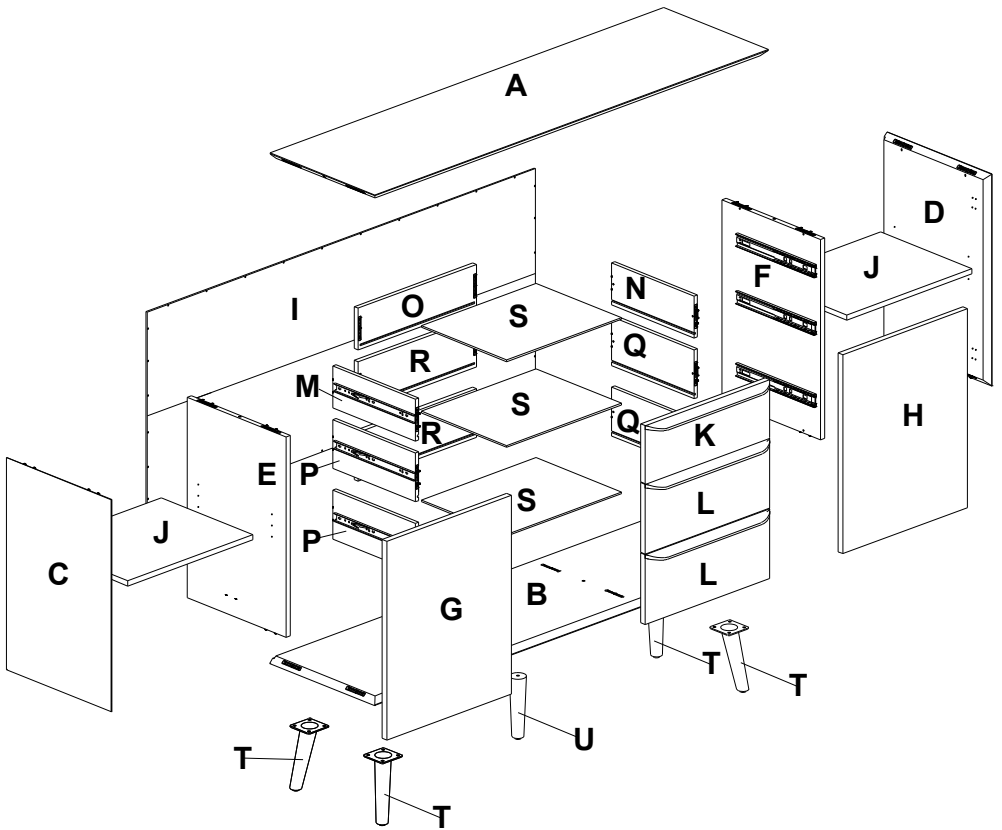

OVERVIEW

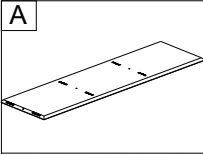
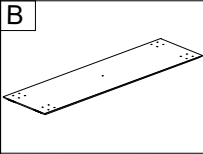
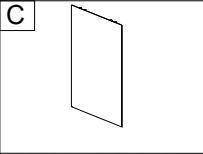
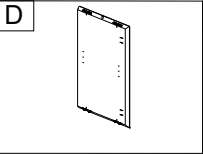
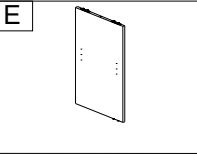
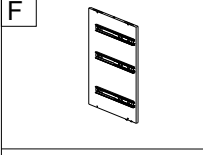
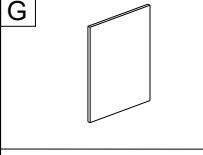
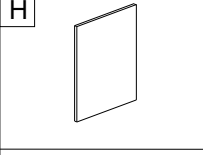
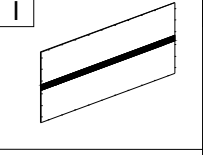
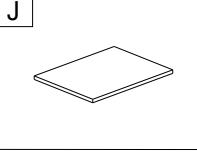
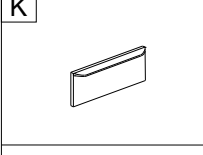
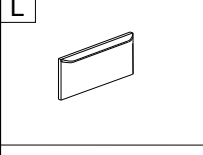
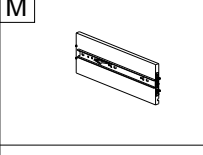
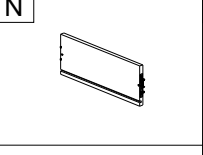
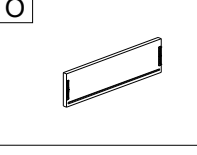
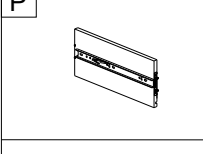
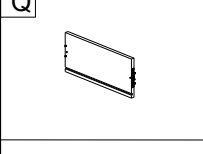
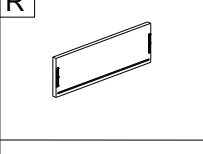
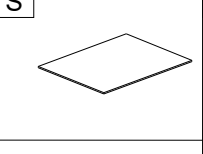
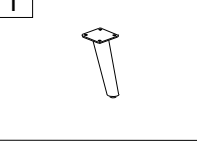
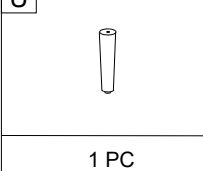

HARDWARE LIST

				
1 PC	1 PC	1 PC	1 PC	1 PC
				
1 PC	1 PC	1 PC	1 PC	2 PCS
				
1 PC	2 PCS	1 PC	1 PC	1 PC
				
2 PCS	2 PCS	2 PCS	3 PCS	4 PCS
				
1 PC				

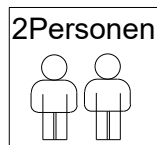

Persons Required For Assembly:

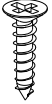

PARTS LIST 1





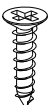





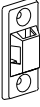

①	x28	②	x26	③	x8
					

SPARE

①	x1	②	x1	③	x1
					

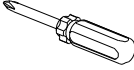

Be sure to inspect all packing material carefully for small parts, that may have come loose inside the carton during shipment.

PARTS LIST 2

④	x16	⑤	x8	⑥	x4	⑦	x2	⑧	x4
									
⑨	x4	⑩	x1	⑪	x4	⑫	x2	⑬	x1
									
⑭	x16	⑮	x16	⑯	x1				
									

Be sure to inspect all packing material carefully for small parts, that may have come loose inside the carton during shipment.



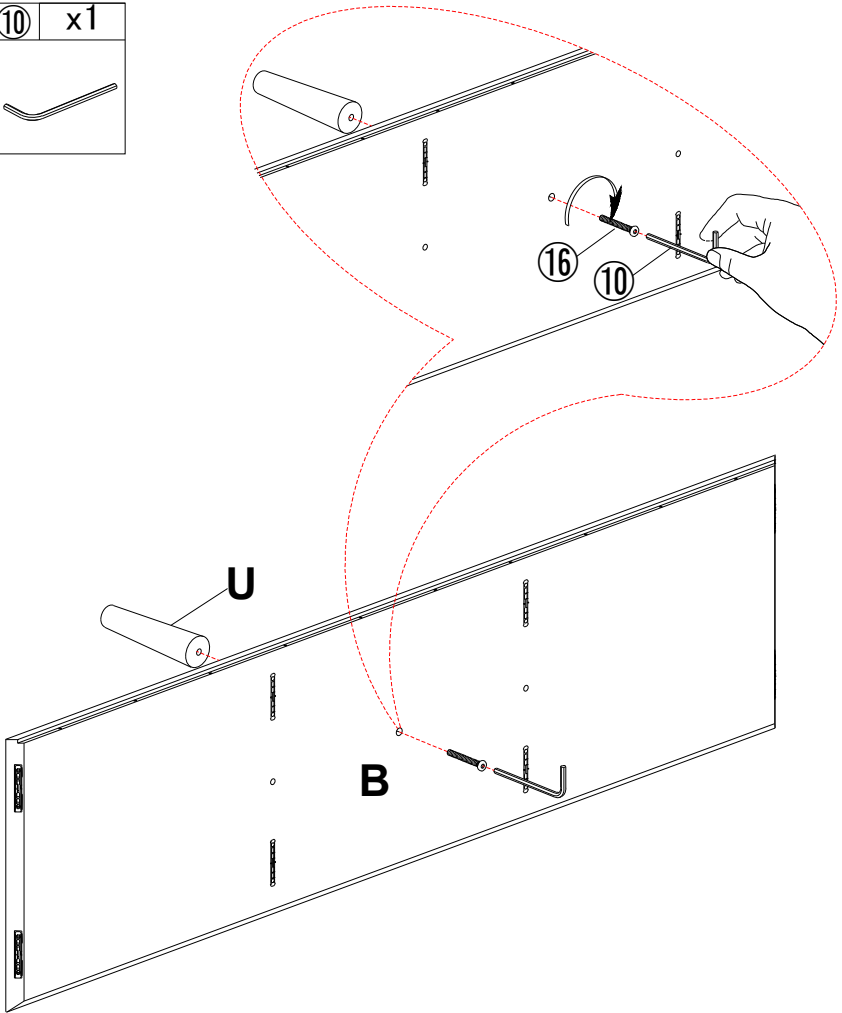

ASSEMBLY INSTRUCTIONS

①6	x1	⑩	x1
			



STEP1:

Use bolt ①6 to attach leg (U) to panel (B), tighten it with allen key ⑩

④	x16	⑩	x1	⑭	x16	⑮	x16
							

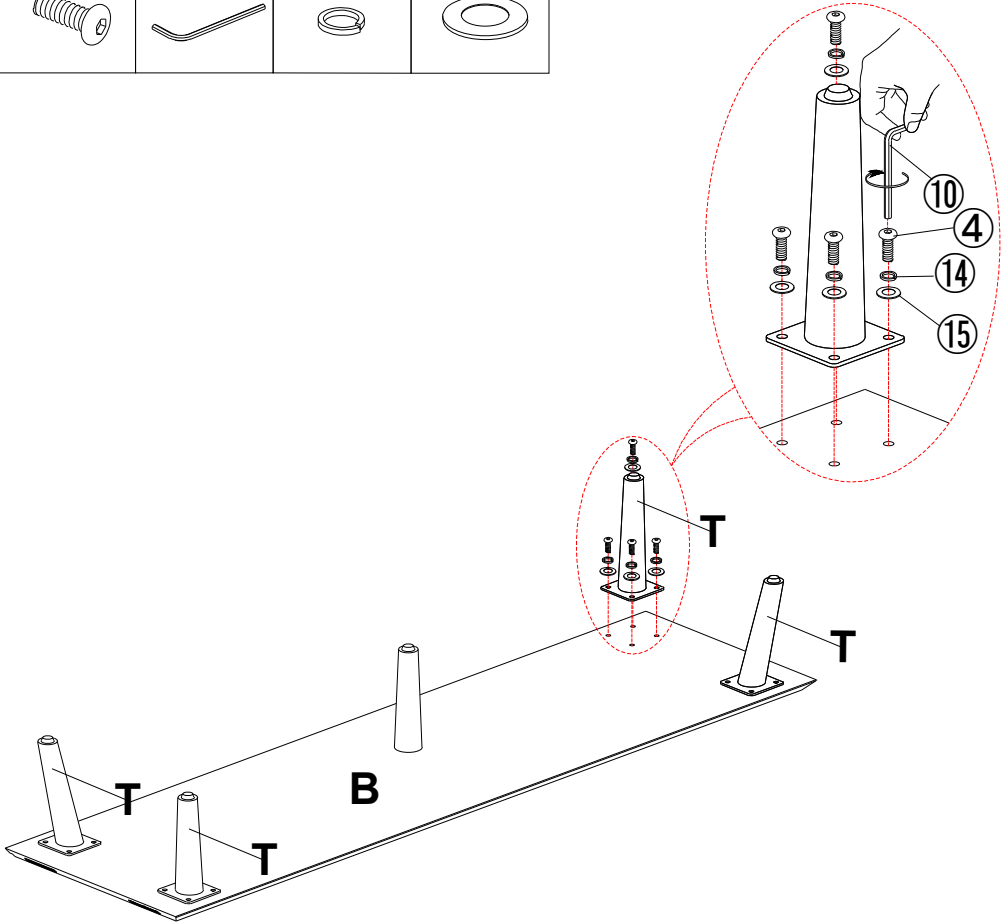

STEP2:

Use plat washer ⑮、spring washer ⑭ and bolt ④ to attach leg T to bottom panel B, tighten it with allen key ⑩.

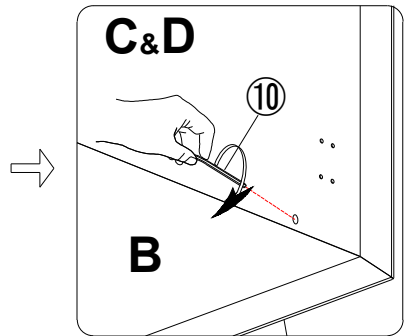
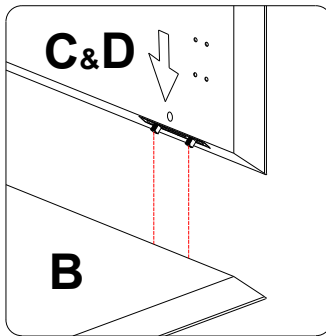
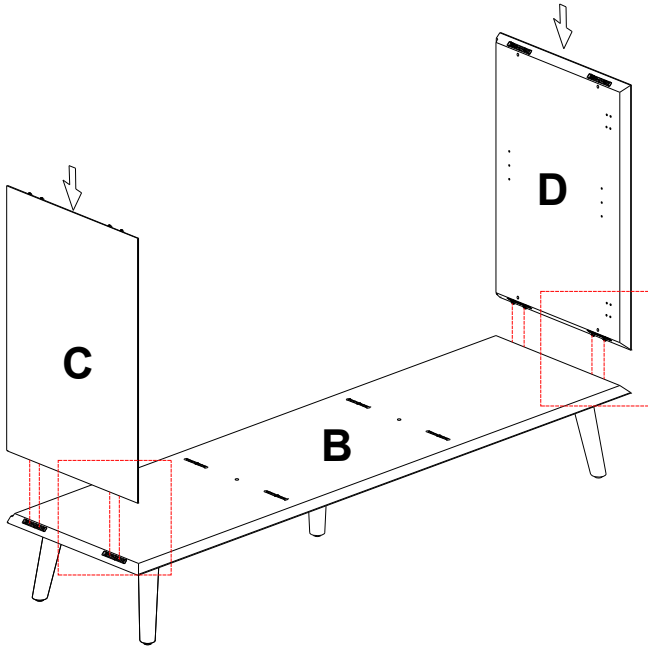
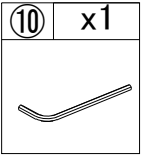

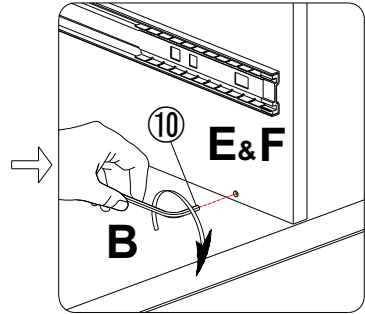
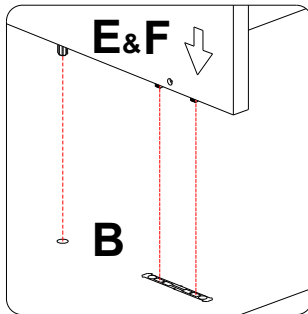
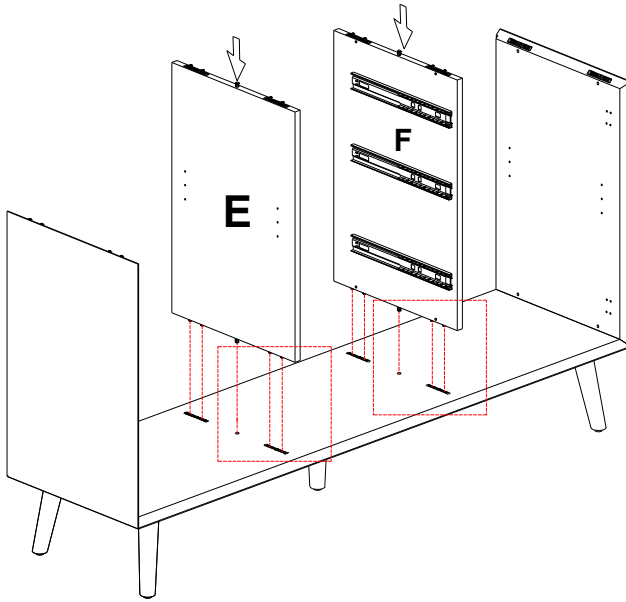
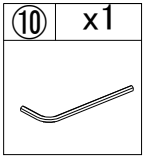

STEP3:

Attach left side panel(C) and right side panel(D) to bottom panel (B), and tighten it with Allen key⑩.



STEP4:

Attach middle vertical panel(E) &(F) to bottom panel (B), and tighten it with Allen key⑩.

③	x8	⑬	x1	⑫	x2
					

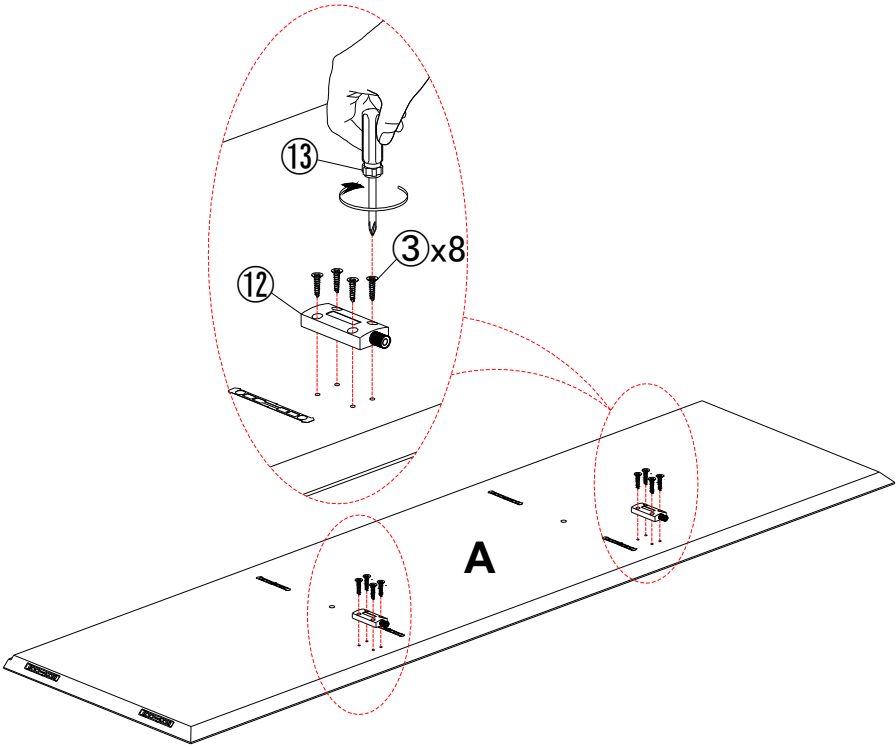

STEP5:

Use screw ③ to attach head rebounder ⑫ to top panel (A),tighten it with screwdriver⑬.

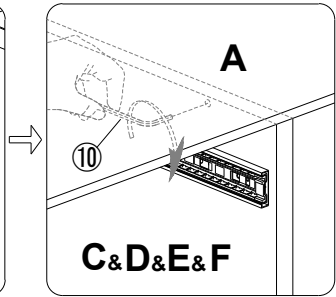
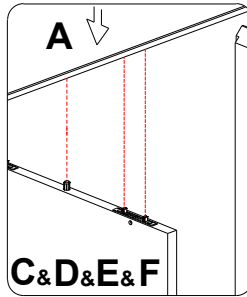
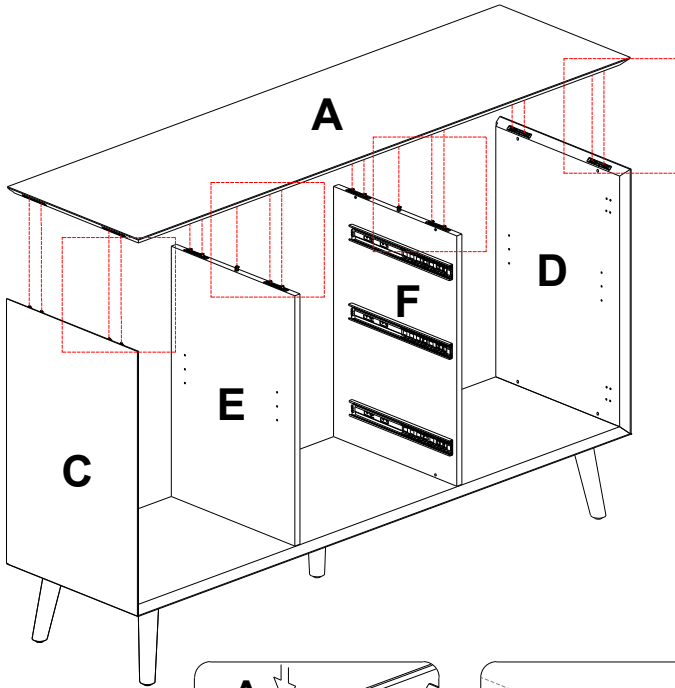
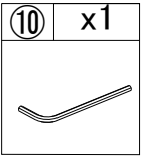

STEP6:

Attach top panel(A) to preassemble unit at step 5 as image, and tighten it with Allen key⑩.

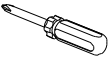
②	x26	⑬	x1
			

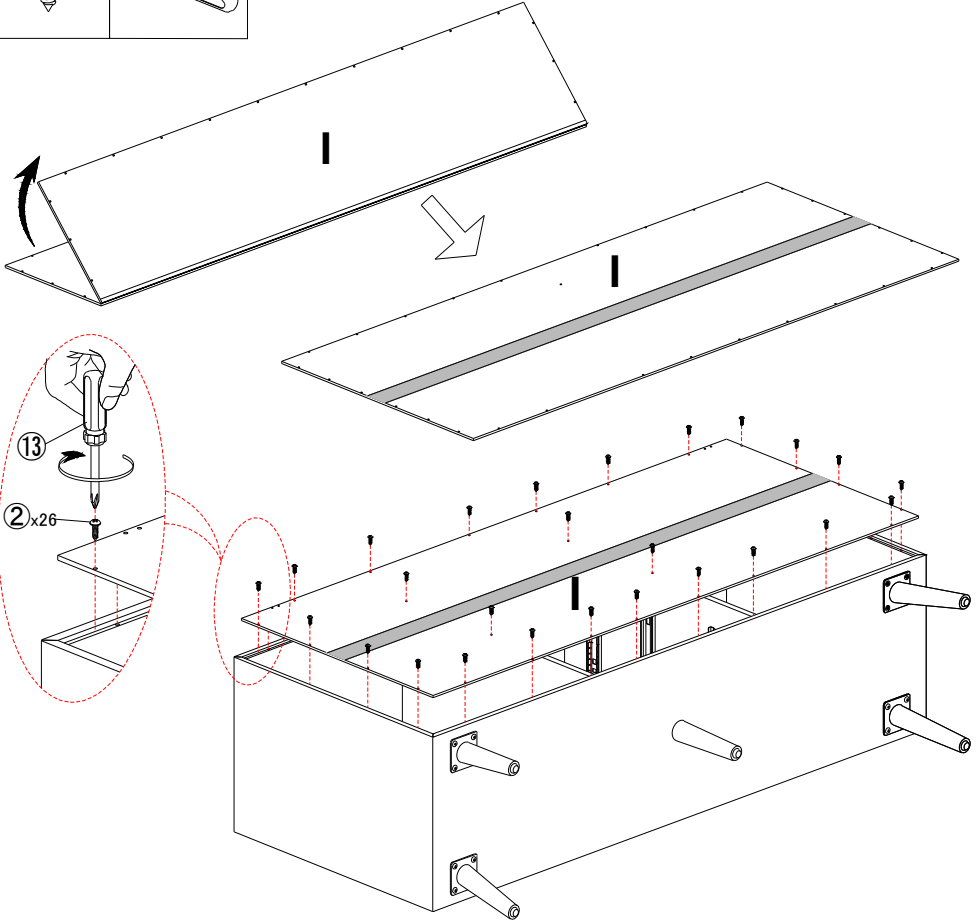

STEP7:

Attach back panel(I) to preassemble unit at step 6 with screw ②, and tighten it with screwdriver ⑬.

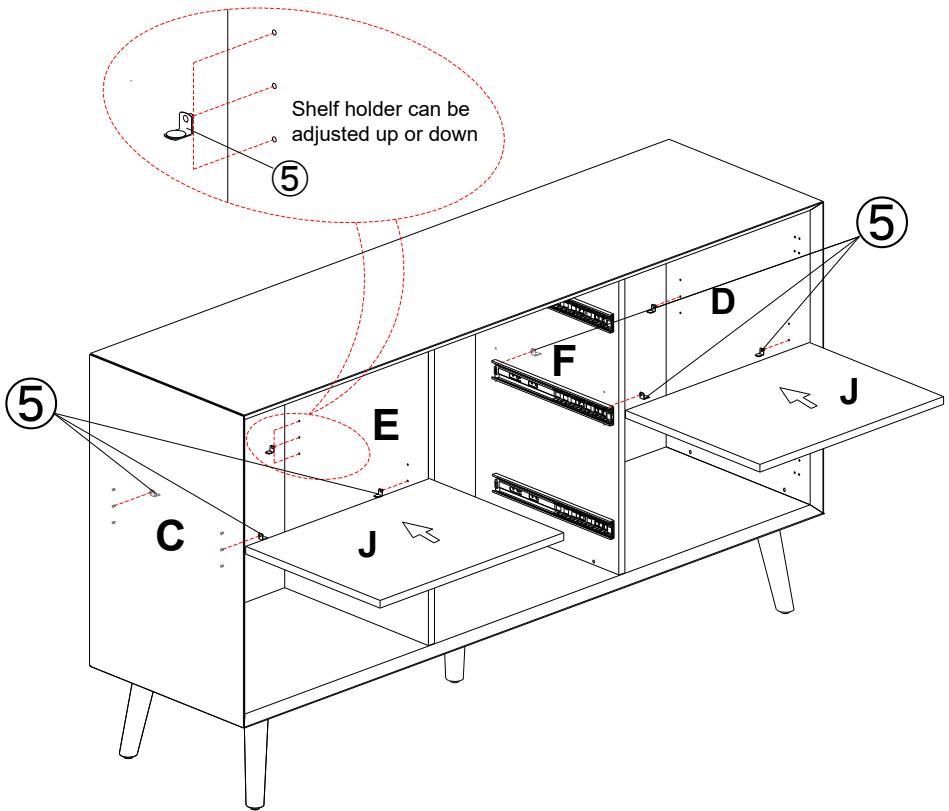
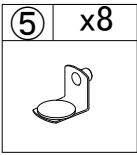

STEP8: Insert shelf pin ⑤ to preassemble unit at step 7 , and attach adjustable shelf (J) to it.

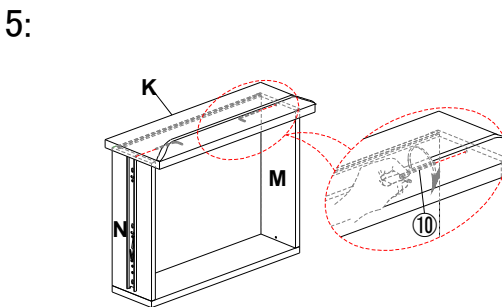
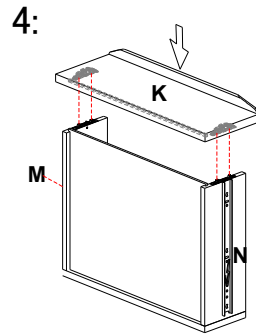
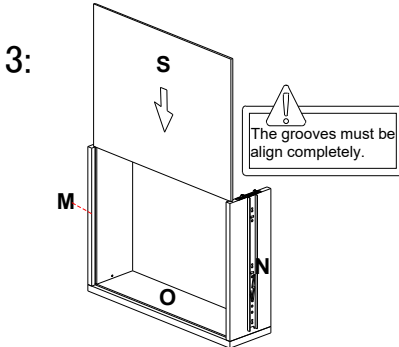
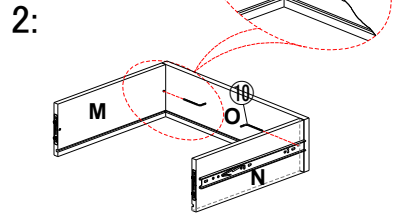
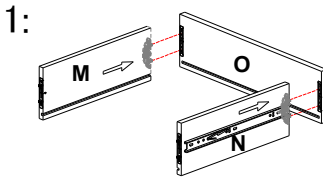
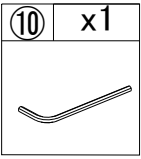

STEP9:

1. Insert drawer left panel (M) and drawer right panel (N) into drawer back panel (O).
2. Use allen key (10) to tighten them as image.
3. Insert drawer bottom panel (S) into the rear slots of drawer side panels (M) & (N) & (O)
4. Insert drawer front panel (K) into the preassembly unit at step 1.3
5. Use allen key (10) to tighten them as image.

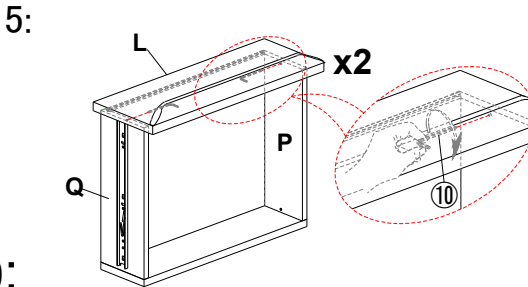
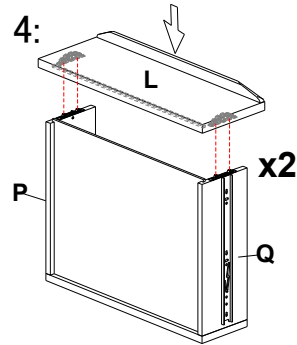
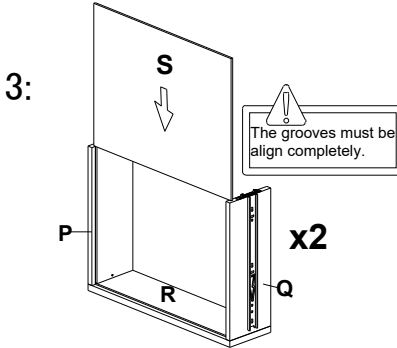
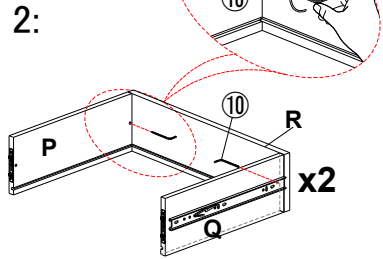
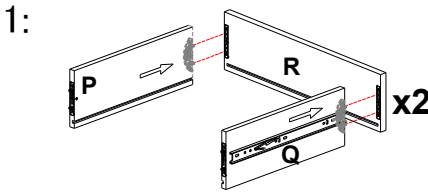
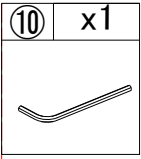

STEP10:

1. Insert drawer left panel (P) and drawer right panel (Q) into drawer back panel (R).

2. Use allen key ⑩ to tighten them as image.

3. Insert drawer bottom panel (S) into the rear slots of drawer side panels (P) & (Q)&(R)

4. Insert drawer front panel (L) into the preassembly unit at step 1.3

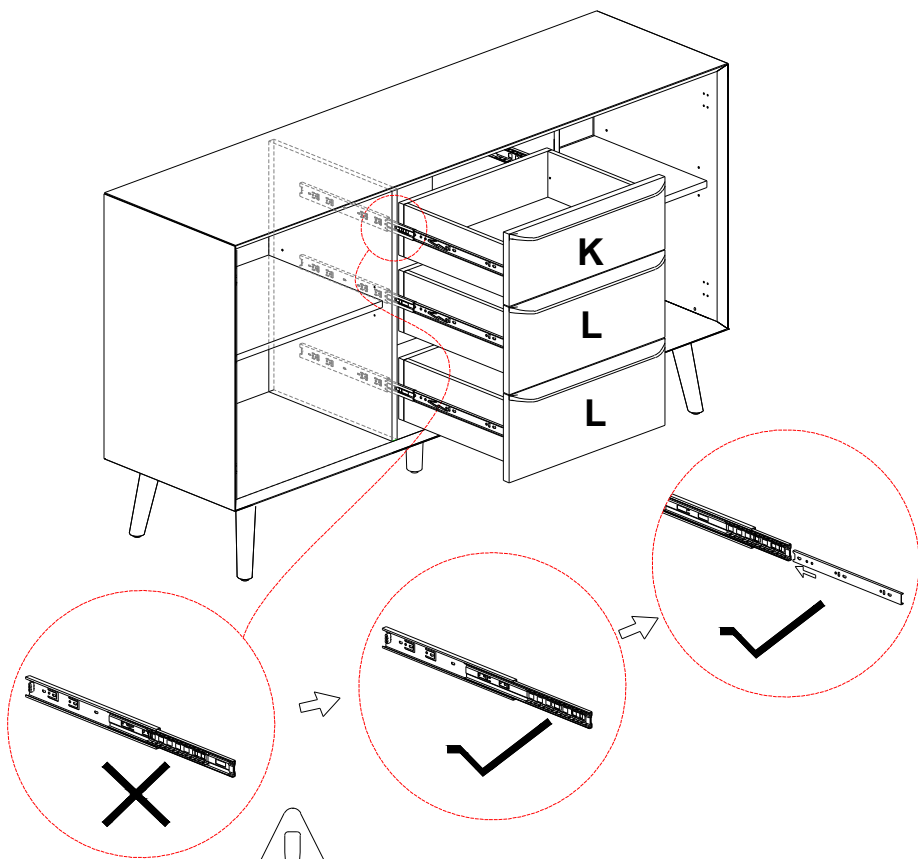

5. Use allen key ⑩ to tighten them as image.

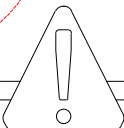

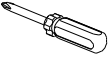

Attention: When installing the drawer, slide the steel ball side rail of side panel to the most front as picture show.

STEP11:

Insert the drawer male sliding rail into the female sliding rail as picture show.

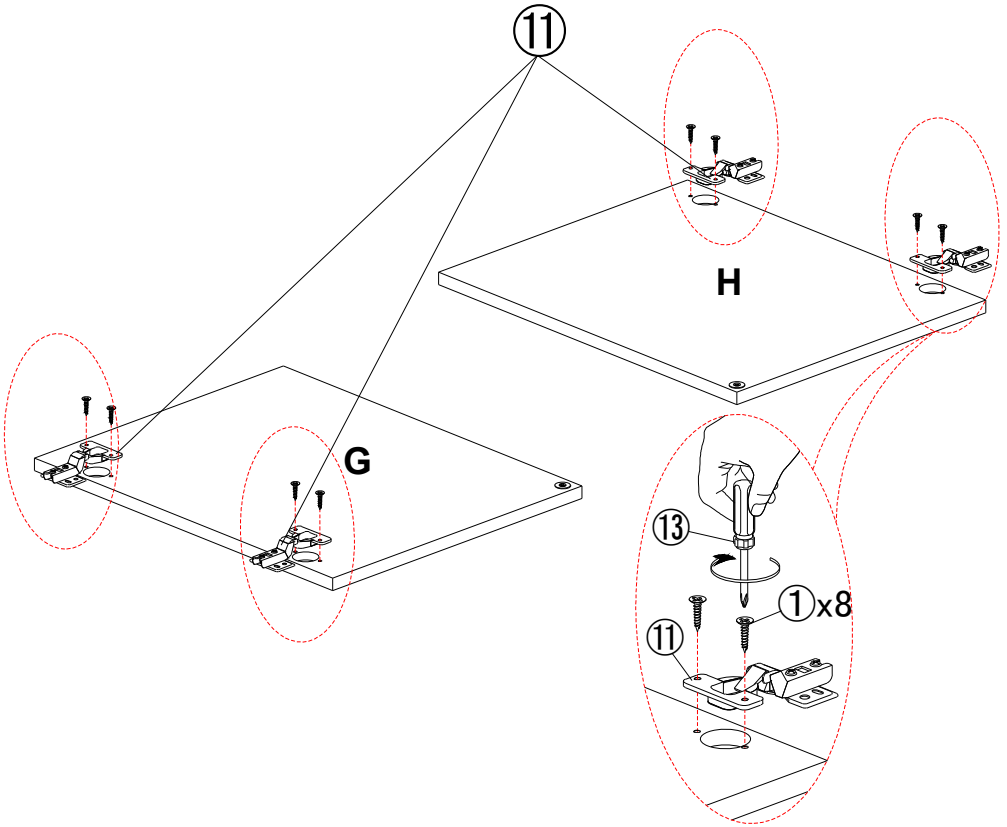
①	x8	⑬	x1	⑪	x4
					



STEP12:

Use screw ① to attach the hinge ⑪ to left door G and right door H, tighten it with screwdriver ⑬.

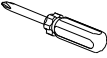
①	x16	⑬	x1
			

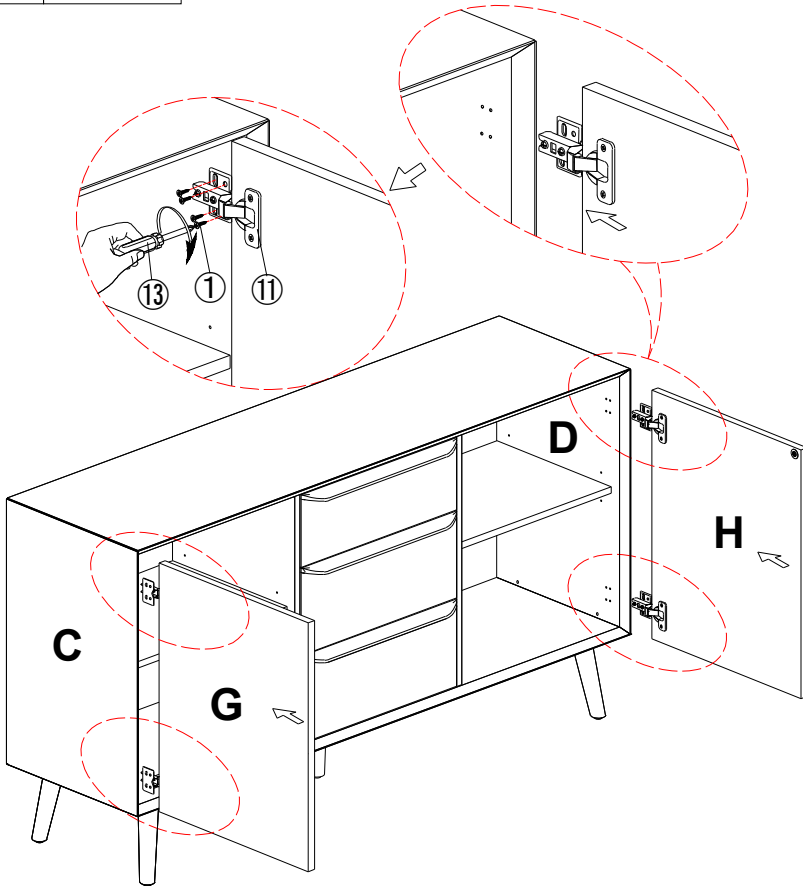

STEP13:

Use screw ① to attach left door (G) and right door (H) to preassemble unit at step 11 ,tighten screw with screwdriver ⑬.

Concealed hinges are three-way adjustable:

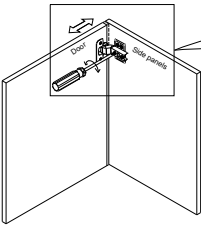

Horizontal
by screw adjustment!

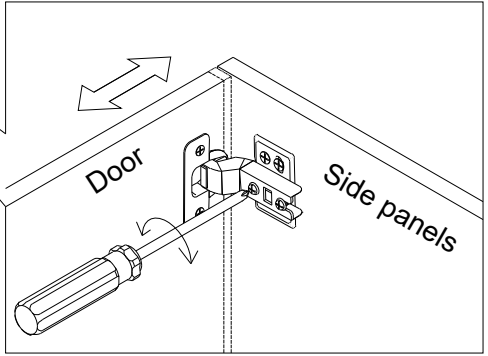

Concealed hinges are three-way adjustable:

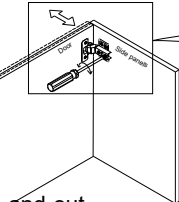

In-and-out
by loosening the hinge arm
mounting screw or via cam
adjustment!

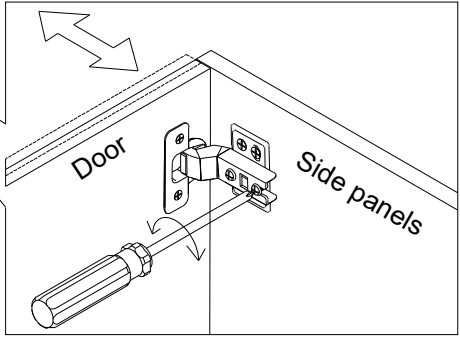

Concealed hinges are three-way adjustable:

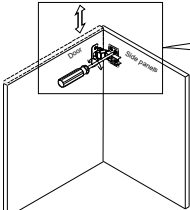

Vertical via slots in
the mounting plate
or via cam adjustment!

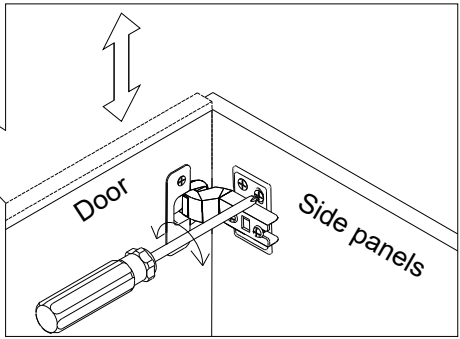

Hinge adjustment method





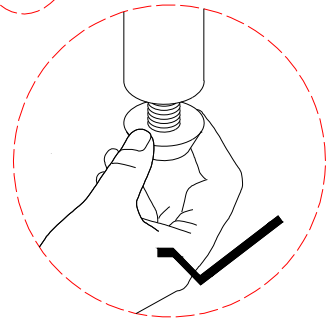
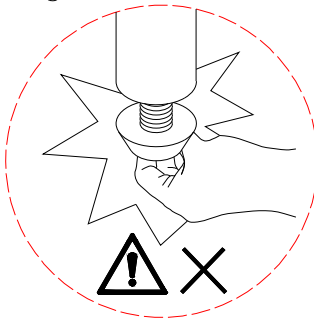
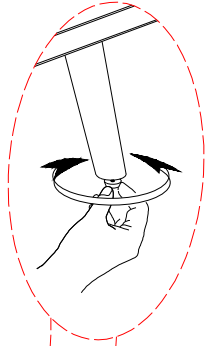
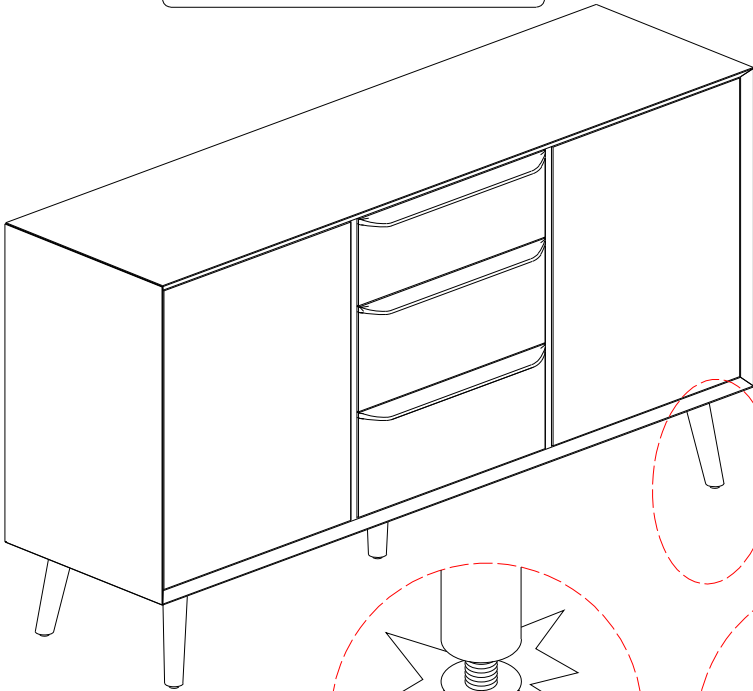

Attention:
After installation, adjust the
adjustable leveler to keep
the cabinet balanced .

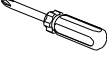

STEP14:

Attention:

After installation, adjust the adjustable
leveler to keep the cabinet balanced .

①	x4	⑬	x1	⑦	x2	⑧	x4	⑨	x4	⑥	x4
											

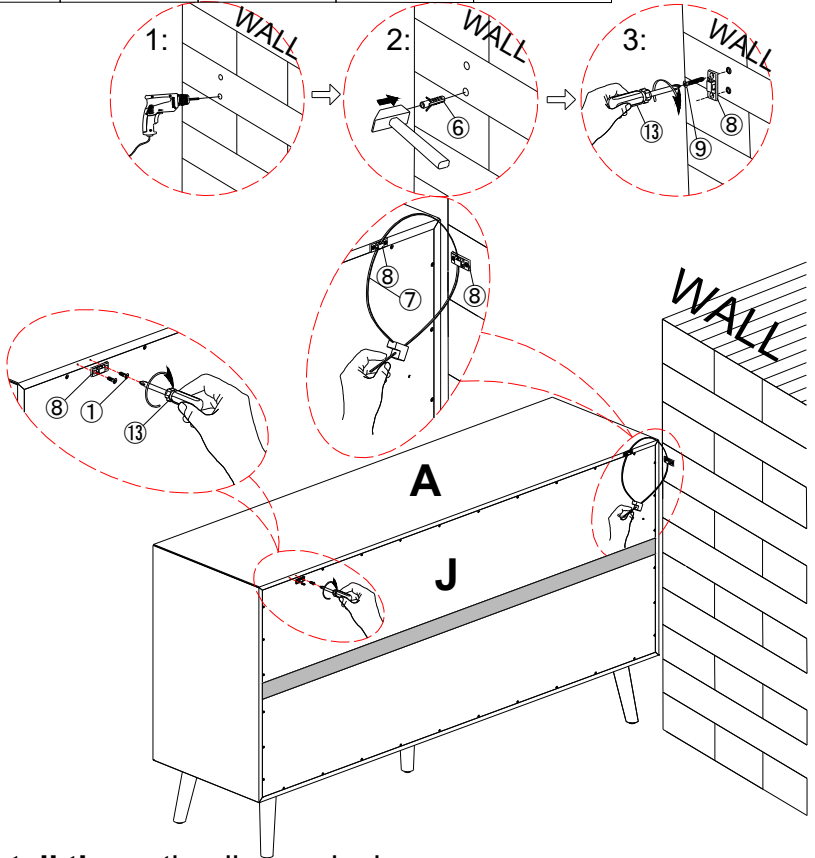

STEP15: Install the anti-collapse device.

1. Mark the position on the wall, that corresponds to the location of part ⑧ on the back of panel J; Drill and insert the expandable screw ⑥ by hammer.
2. Assemble the part ⑧ to the wall. Align the hole in the part ⑧ with the expandable screw ⑥, screw ⑨ in and tighten by screwdriver.
3. Let the plastic belt ⑦ pass through the both part ⑧ and pull tightly.

WARRANTY

We strive to offer high-quality products, and we also try our best to satisfy each and every customer that orders from us with product or service as needed. We provide 30 days warranty starting from the time you receive the item. Each customer must provide a record of their order such as the order number, or item receipt for any items that are out of the warranty period you may also still receive replacement parts by purchasing them with our company if they are available.

Are you having difficulty
with assembly? Missing parts?
Please send email with your order No to
customerservice@hulalahome.com
For return, please check the return policy with
the retailer or market place you bought from.

Appreciate your purchasing from us.
Pop up your life by our furniture piece!