

HULALA

H O M E

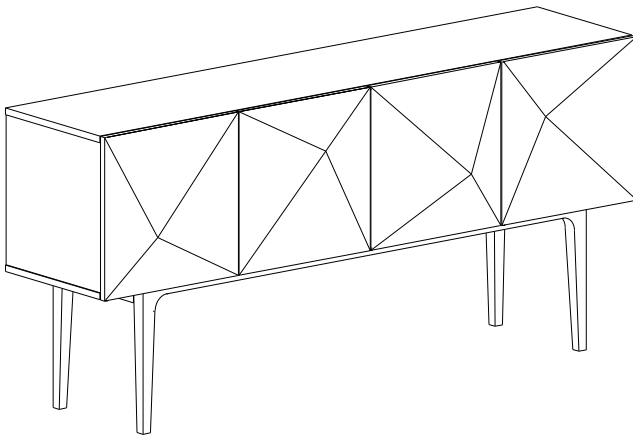

ITEM NO.SBHM0736

NOTE:

This brochure contains IMPORTANT safty info. Please read and keep for future reference.

MAINTAINANCE AND WARNING

- Keep furniture away from heat sources.
- Do not clean furniture with harsh cleaner or polishes. Do not use detergents, Solvents, abrasives, spray packs or leather cleaner. Use non-color mild soap with warm water to clean spills (Mix 1:10 soap to water)
- Do not place furniture under direct sunlight, material will possibly fade over time.
- Do not use on site dry Cleaning machine. Children should not climb or jump on the furniture.
- Do not write on furniture that is not protected by a padded barrier .
- Not for commercial use, only for residential use.







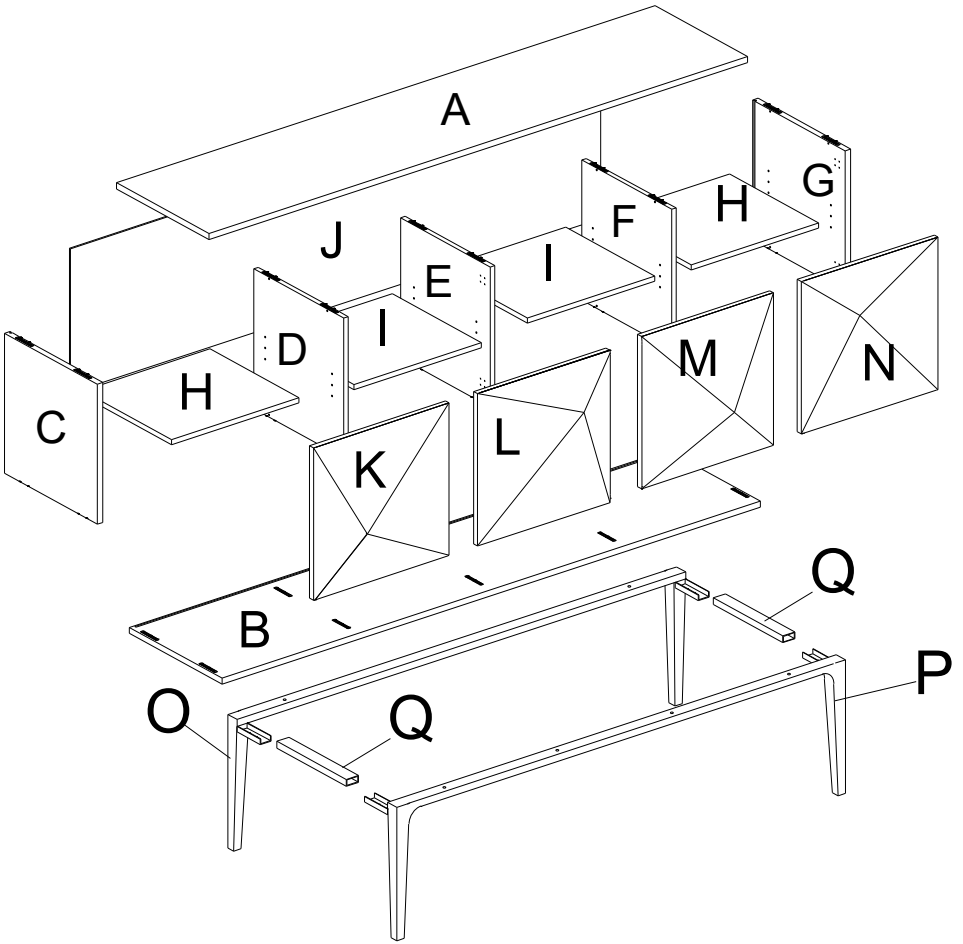

Weight Limitation

150LBS

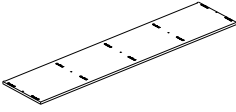
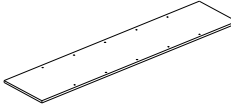
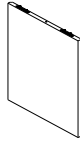
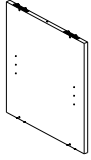
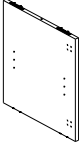

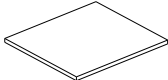
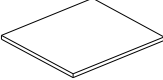
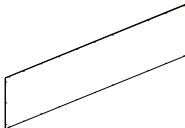
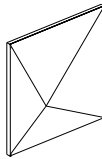
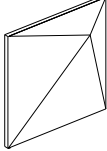
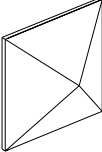
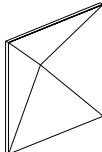
OVERVIEW



HARDWARE LIST

A 	B 	C 	D 
1 PC	1 PC	1 PC	1 PC
E 	F 	G 	H 
1 PC	1 PC	1 PC	2 PCS
I 	J 	K 	L 
2 PCS	1 PC	1 PC	1 PC
M 	N 	O 	P 
1 PC	1 PC	1 PCS	1 PCS
Q 			
2 PCS			

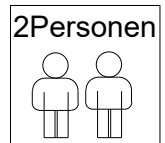

Persons Required For Assembly:



PARTS LIST 1











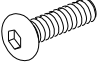

①	x52	④	x27
			

SPARE

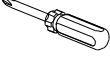
①	x1	④	x1
			

Be sure to inspect all packing material carefully for small parts, that may have come loose inside the carton during shipment.

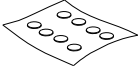
PARTS LIST 2

②	x8	③	x10	⑤	x16	⑥	x4	⑦	x4
									
⑧	x1	⑨	x1	⑩	x4	⑪	x2	⑫	x4
									
⑬	x4	⑭	x1	⑮	x18	⑯	x18		
									

Be sure to inspect all packing material carefully for small parts, that may have come loose inside the carton during shipment.

ASSEMBLY INSTRUCTIONS

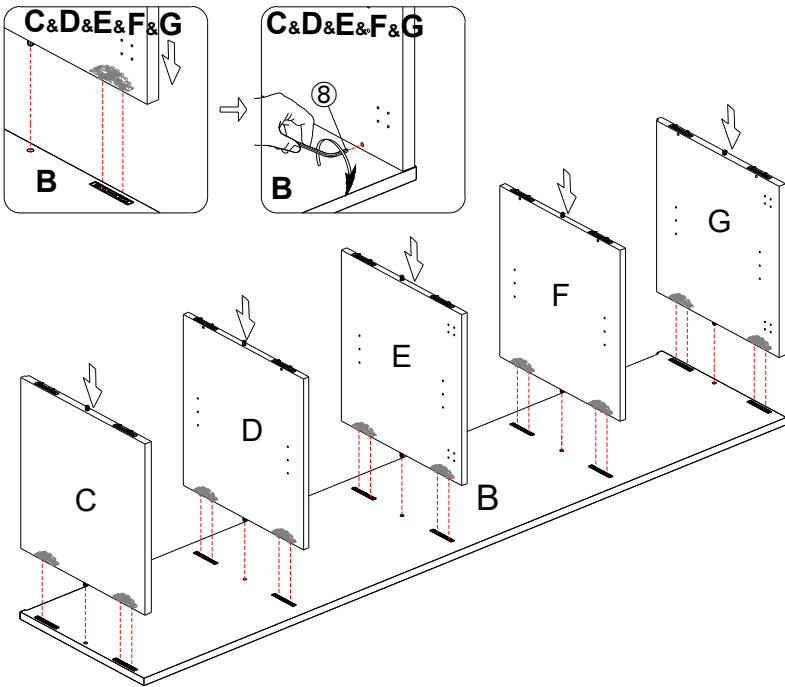
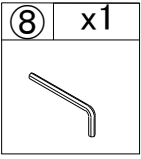

STEP1:

Insert left side panel (C)、 middle vertical panel D&E&F and right side panel (G) into the corresponding hole of bottom panel (B) as image, then tighten it with allen key ⑧

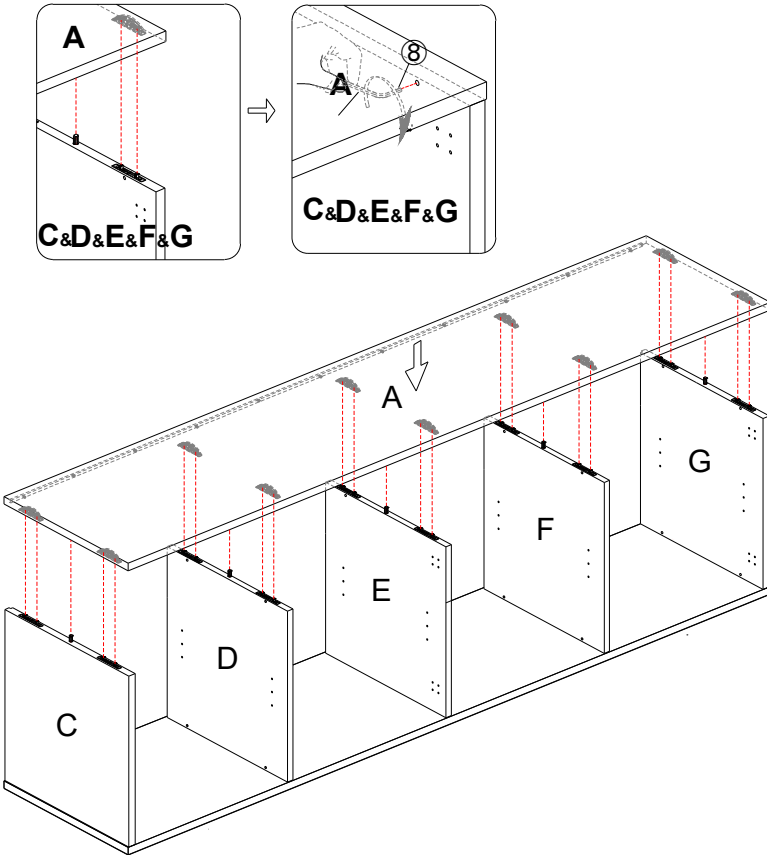
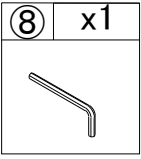

STEP2:



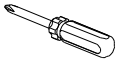

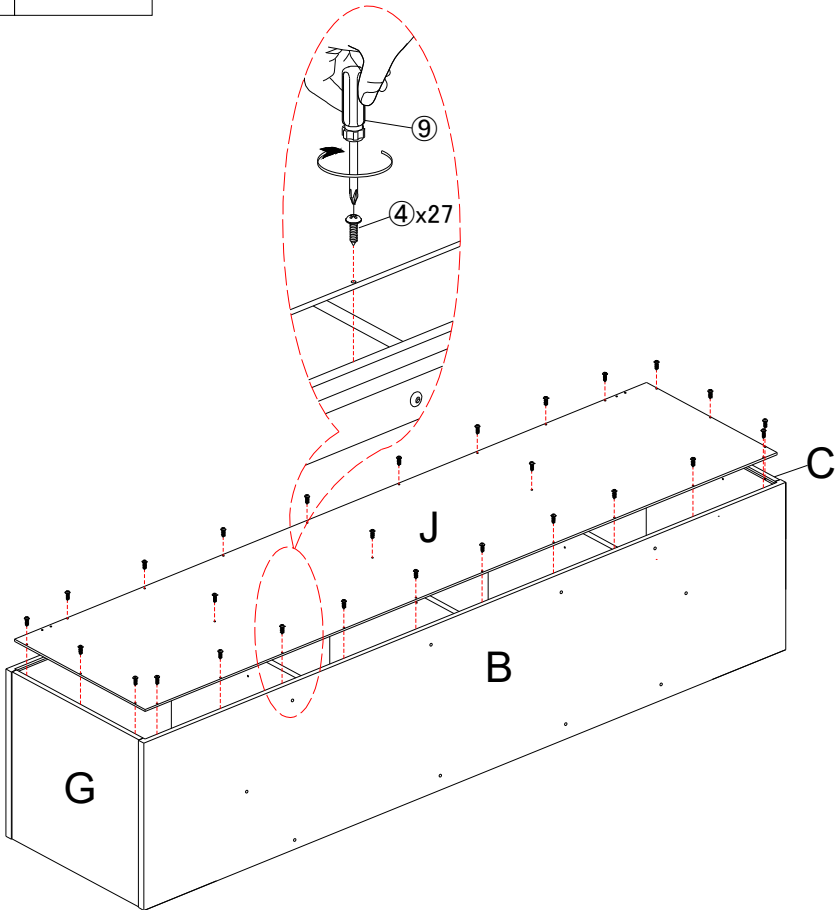
Attach top panel (A) to preassemble unit at step 1 as image, and tighten it with allen key ⑧

④	x27	⑨	x1
			



STEP3:



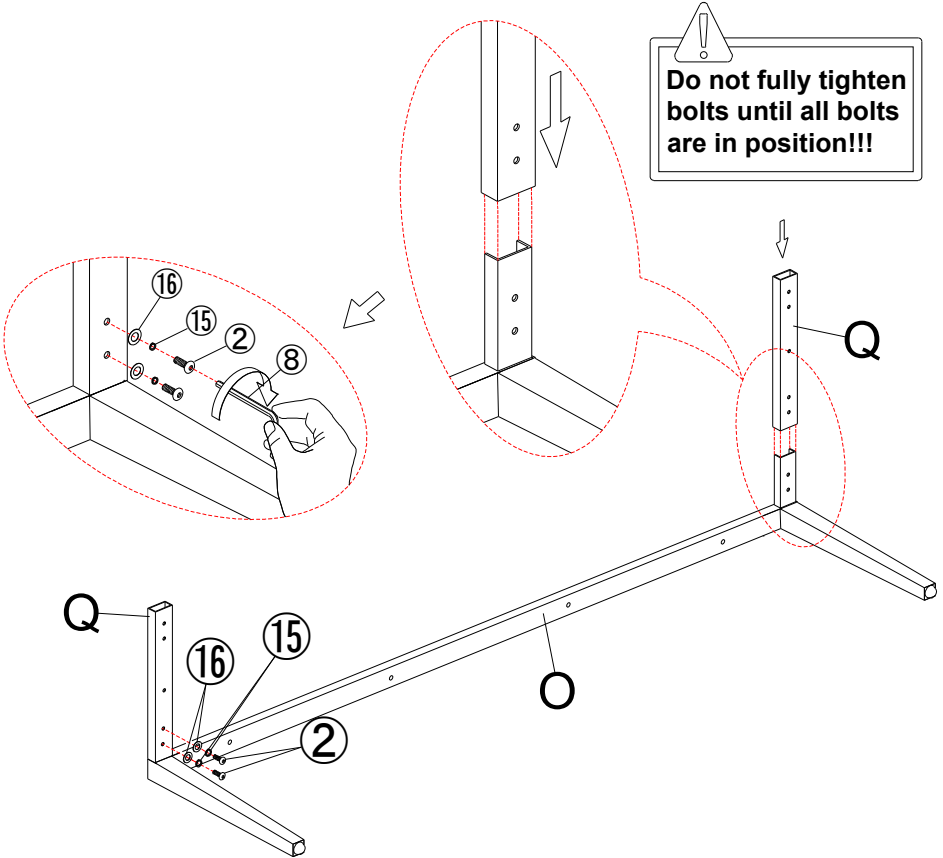

Attach back panel (J) to preassemble unit at step 2 with screw ④, and tighten it with screwdriver ⑨.

⑧	x1	②	x4	⑮	x4	⑯	x4
							



STEP4:



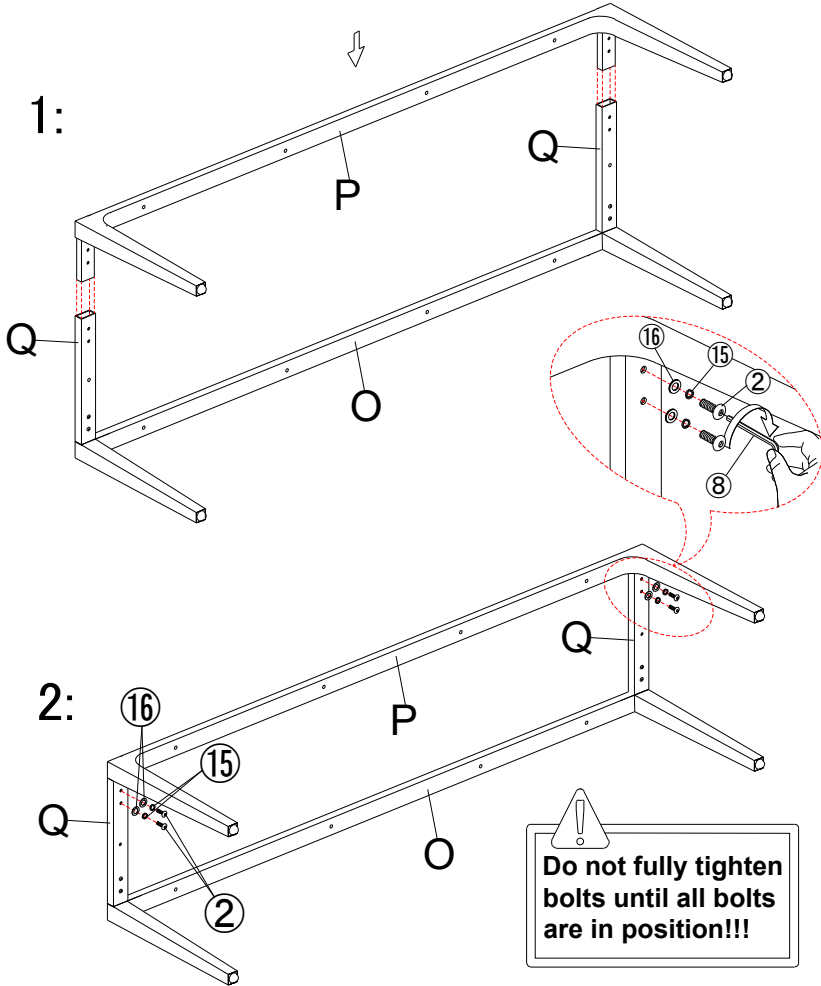

Insert part (Q) into part (O) as picture show, then use flat washer ⑯、spring washer ⑮ and bolt ② to attach part (Q) to part (O), make sure all holes aligned and tighten all bolts with allen key ⑧.

⑧	x1	②	x4	⑮	x4	⑰	x4
							



STEP5:

Insert part (P) into part (Q), use plat washer ⑰、spring washer ⑮ and bolt ② to attach part (Q) to part (P),make sure all holes aligned and tighten all bolts with allen key ⑧.

⑧	x1	③	x10	⑮	x10	⑯	x10
							

 **Do not fully tighten bolts until all bolts are in position!!!**

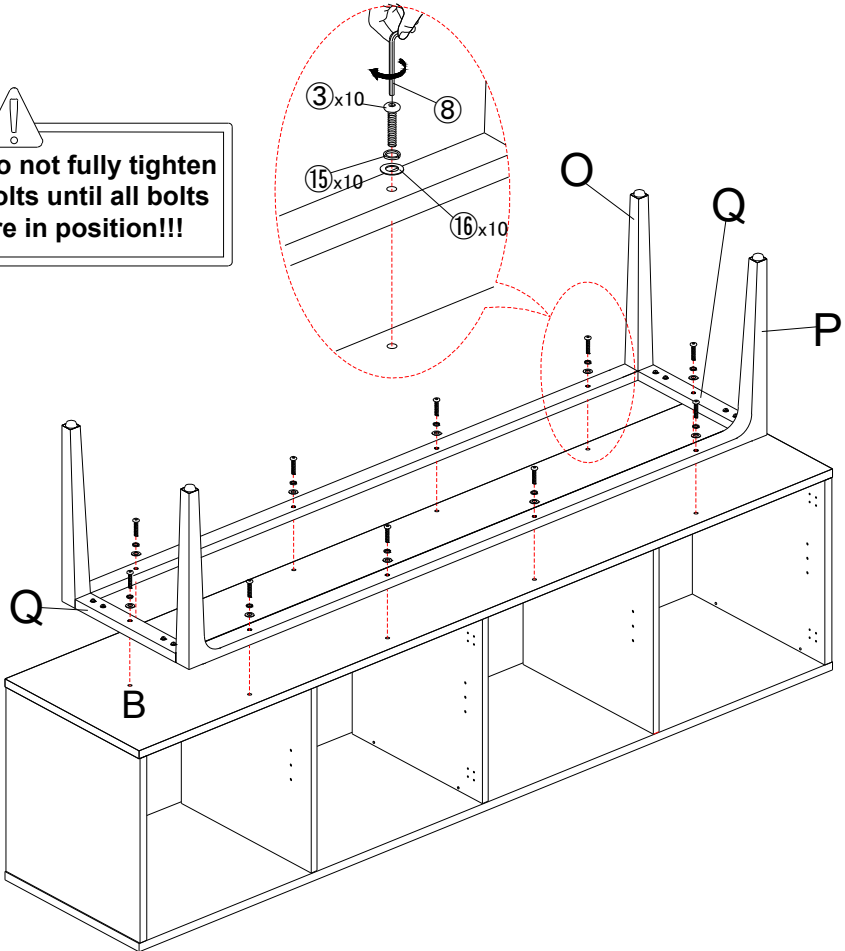

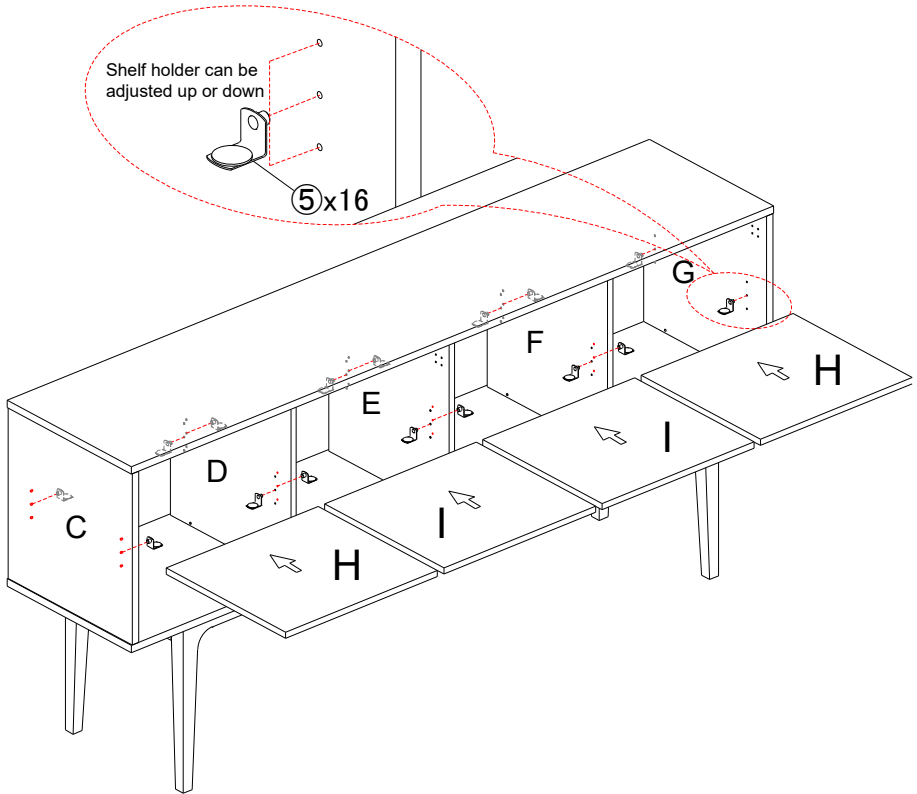
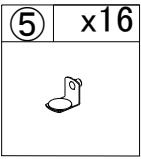

STEP6:

Use flat washer ⑯、spring washer ⑮ and bolt ③ to attach the preassembly unit at step 5 to panel (B), make sure all holes aligned and tighten all bolts with allen key ⑧.

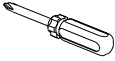

STEP7:

Insert shelf pin ⑤ into preassemble unit at step 6, and attach adjustable shelf H&I to it.

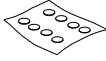
①	x16	⑨	x1	⑦	x4	⑥	x4	⑭	x1
									

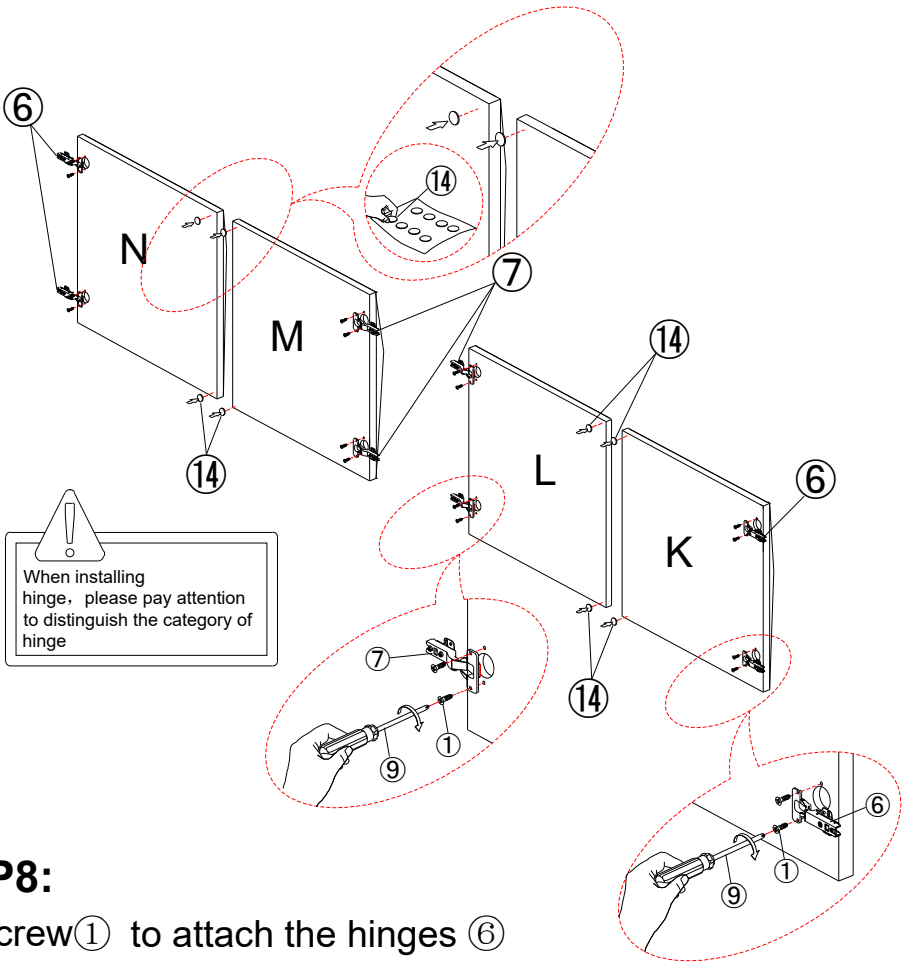

STEP8:

Use screw ① to attach the hinges ⑥ to door panel N&K, tighten screws with screwdriver ⑨.

Use screw ① to attach the hinges ⑦ to door panel M&L, tighten screws with screwdriver ⑨.

Stick parts ⑭ on panel N&M&L&K as image.

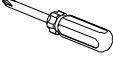
①	x16	⑨	x1
			

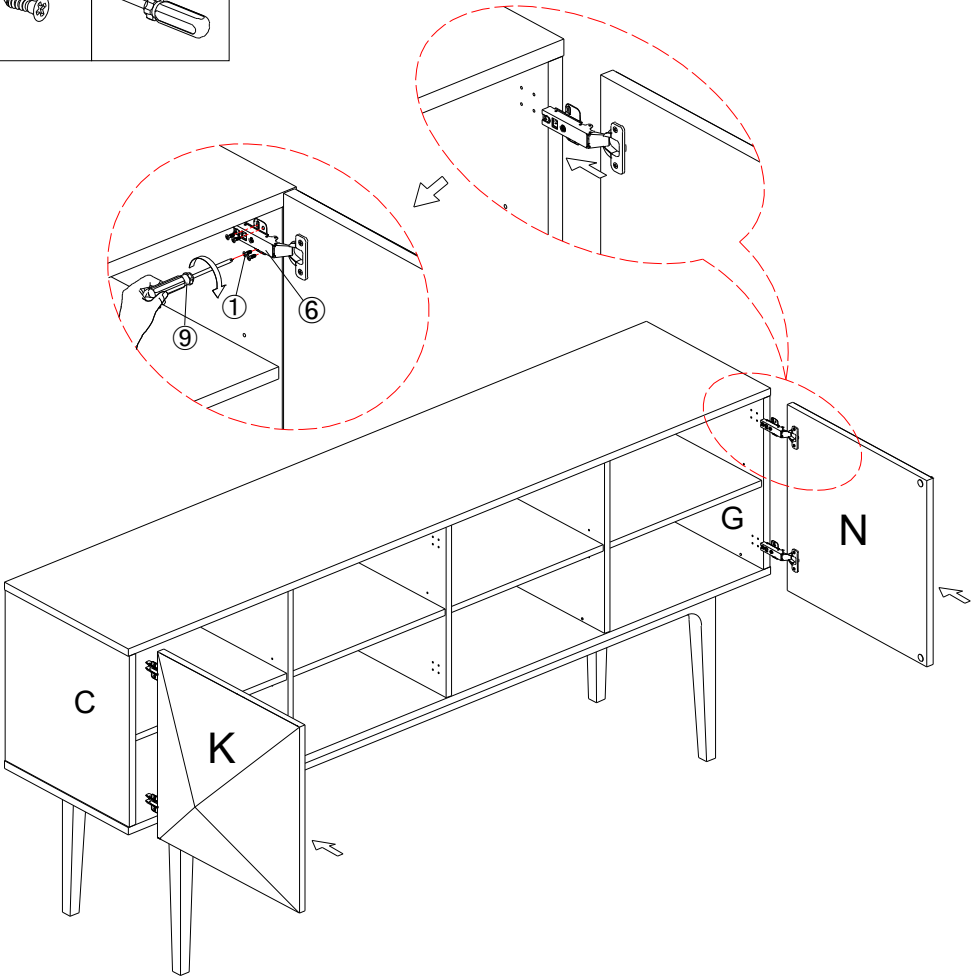

STEP9:

Use screw ① to attach left door (K) and right door (N) to preassemble unit at step 8 , tighten screw with screwdriver ⑨.

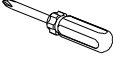
①	x8	⑨	x1
			

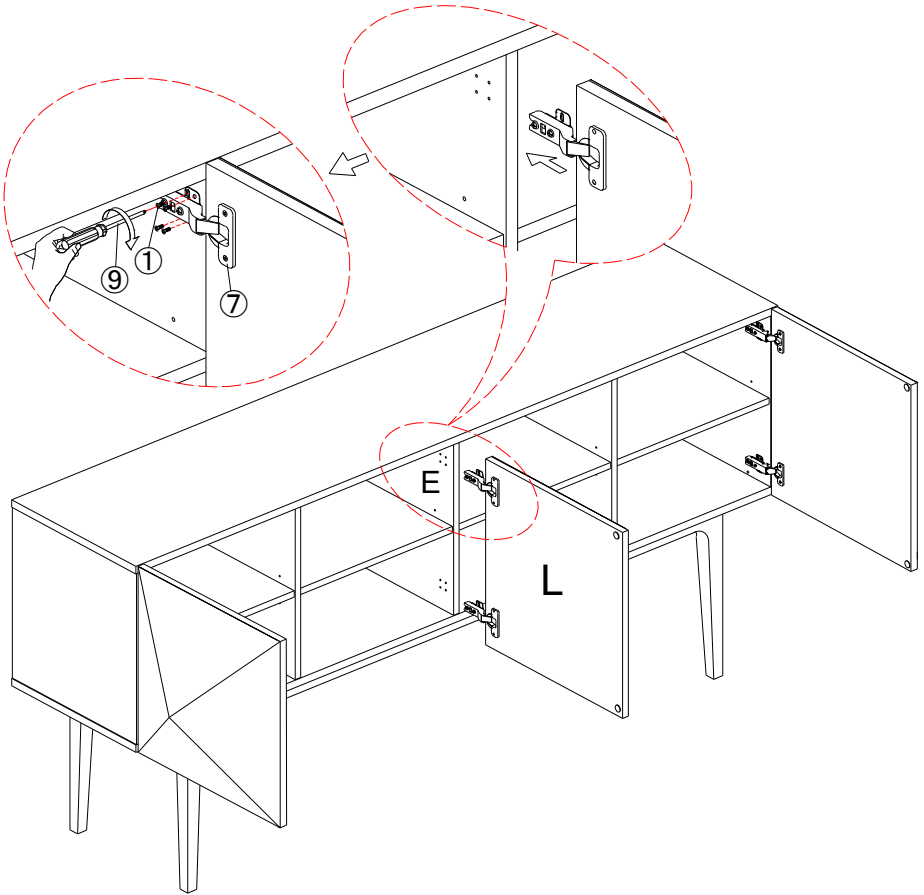

STEP10:

Use screw ① to attach left middle door (L) to preassemble unit at step 9 , tighten screw with screwdriver ⑨ .

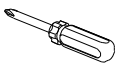
①	x8	⑨	x1
			

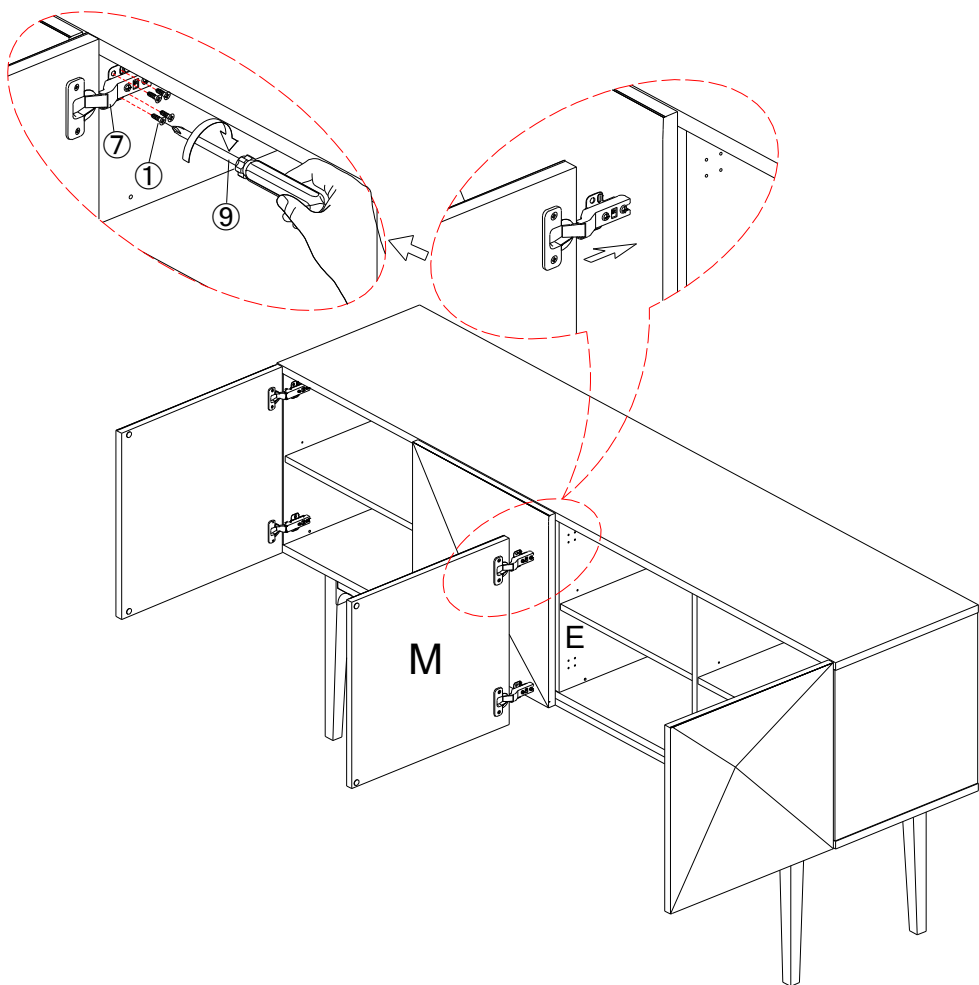

STEP11:

Use screw ① to attach right middle door (M) to preassemble unit at step 10 , tighten screw with screwdriver ⑨ .

Concealed hinges are three-way adjustable:

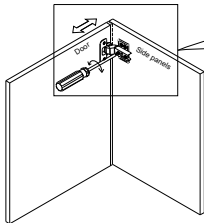

Horizontal
by screw adjustment!

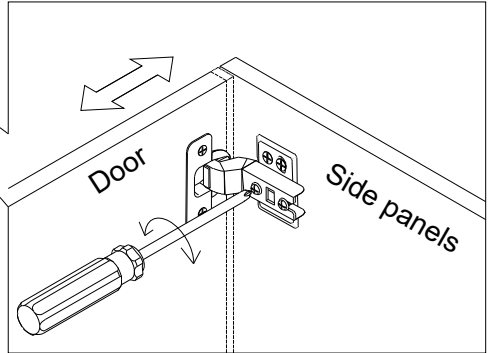

Concealed hinges are three-way adjustable:

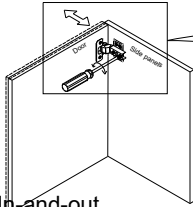

In-and-out
by loosening the hinge arm
mounting screw or via cam
adjustment!

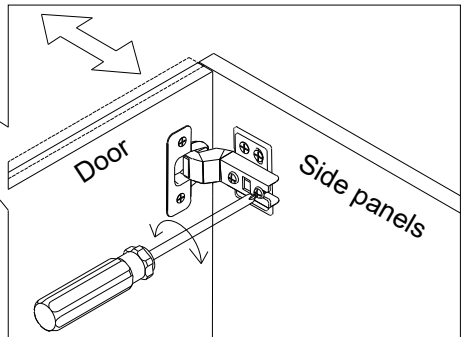

Concealed hinges are three-way adjustable:

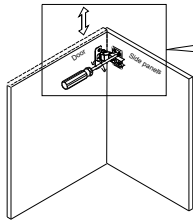

Vertical via slots in
the mounting plate
or via cam adjustment!

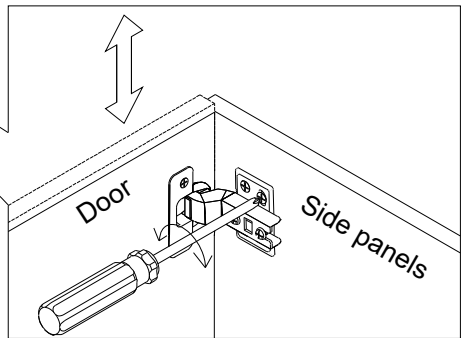

Hinge adjustment method

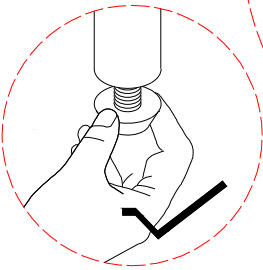
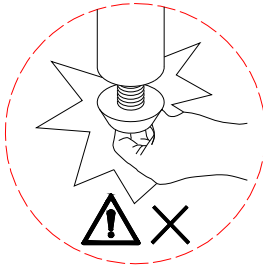
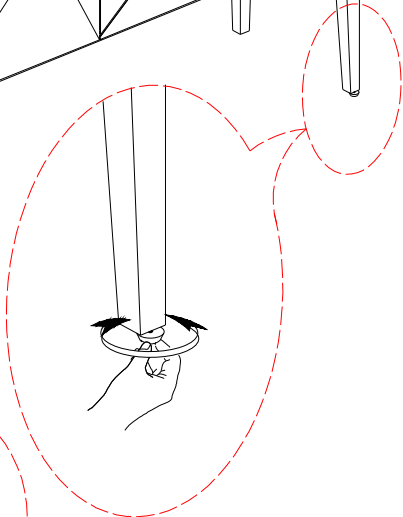
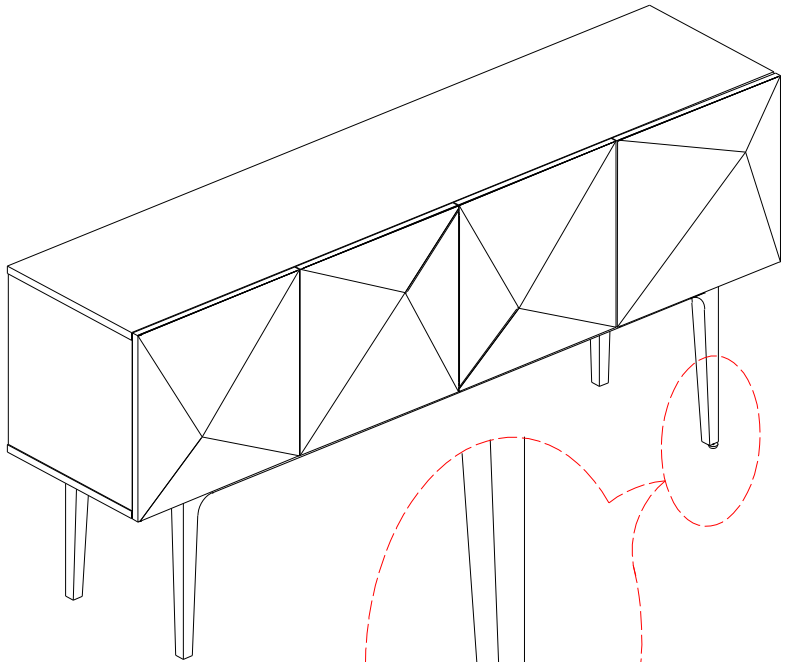

STEP12:

Attention:After installation, adjust the adjustable leveler to keep the cabinet balanced .

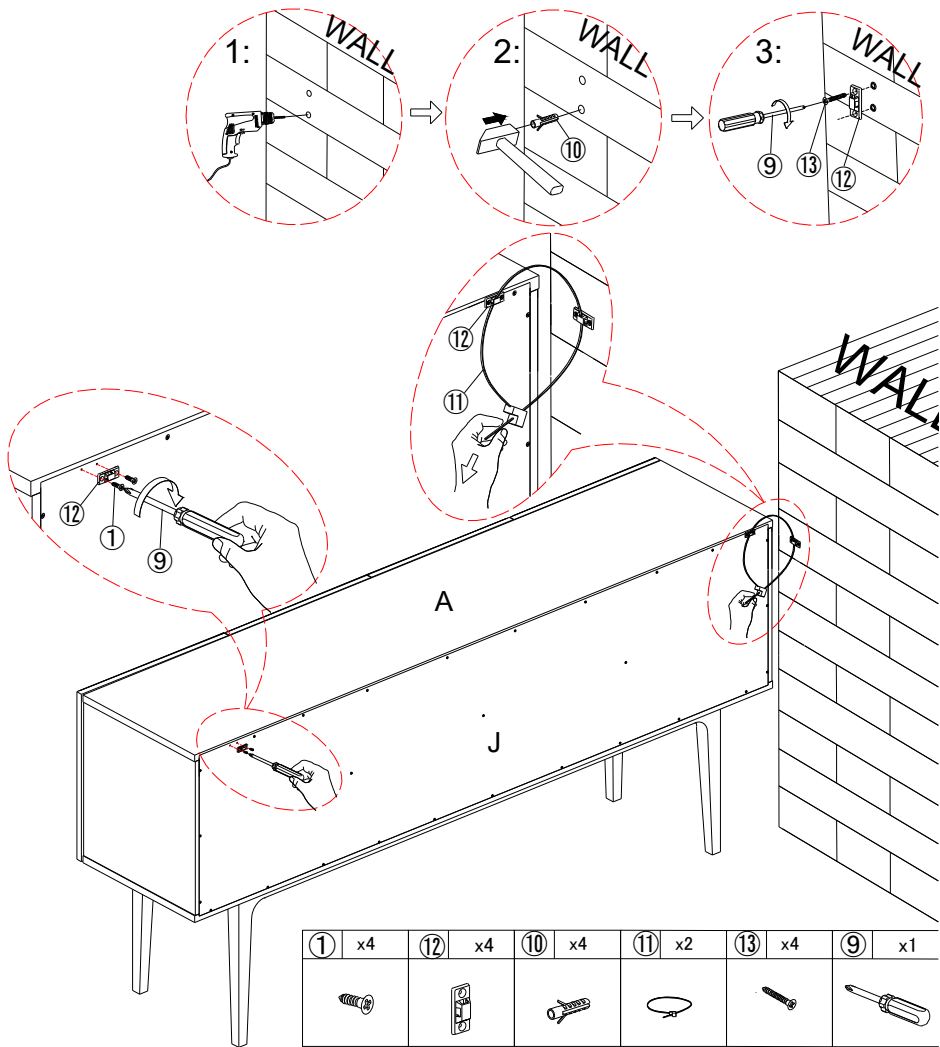

STEP13: Install the anti-collapse device.

1. Mark the position on the wall, that corresponds to the location of part ⑫ on the back of panel J; Drill and insert the expandable screw ⑩ by hammer.
2. Assemble the part ⑫ to the wall. Align the hole in the part ⑫ with the expandable screw ⑩, screw ⑬ in and tighten by screwdriver.
3. Let the plastic belt ⑪ pass through the both part #⑫ and pull tightly.

WARRANTY

We strive to offer high-quality products, and we also try our best to satisfy each and every customer that orders from us with product or service as needed. We provide 30 days warranty starting from the time you receive the item. Each customer must provide a record of their order such as the order number, or item receipt for any items that are out of the warranty period you may also still receive replacement parts by purchasing them with our company if they are available.

Are you having difficulty
with assembly? Missing parts?
Please send email with your order No to
customerservice@hulalahome.com
For return, please check the return policy with
the retailer or market place you bought from.

Appreciate your purchasing from us.
Pop up your life by our furniture piece!