

WARRANTY

We strive to offer high-quality products, and we also try our best to satisfy each and every customer that orders from us with product or service as needed. We provide 30 days warranty starting from the time you receive the item. Each customer must provide a record of their order such as the order number, or item receipt for any items that are out of the warranty period you may also still receive replacement parts by purchasing them with our company if they are available.

Are you having difficulty

with assembly? Missing parts?

**Please send email with your order No
customerservice@hulalahome.com**

**For return, Please check the return policy with
the retailer or MarketPlace you bought from.**

Appreciated your purchasing from us.

Pop up your life by our furniture piece!

HULALA

H O M E

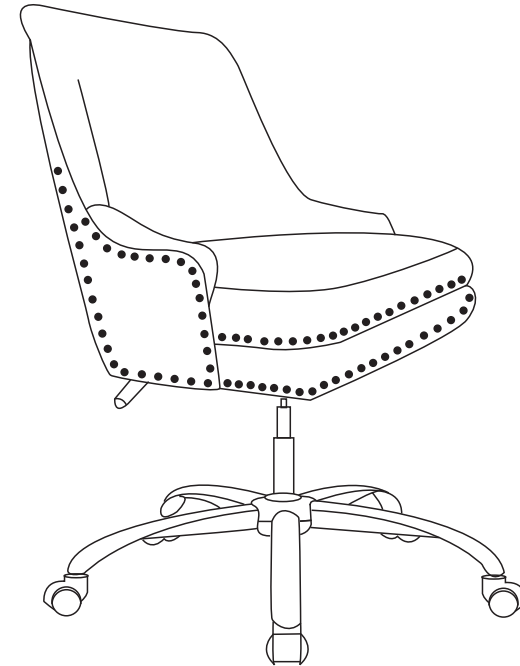

ITEM NO.OFM0002/OFM0003

NOTE:

This brochure contains IMPORTANT safty info. Please read and keep for future reference.

MAINTAINANCE AND WARNING

- Keep furniture away from heat.
- Do not clean furniture with harsh cleansers or polish. Do not use detergents, Solvents, abrasives, spray packs or leather cleaner. Use non-color mild soap with warm water clean spills(Mix 1:10 soap to water)
- Do not place furniture under direct sunlight, material will possibly fade over time.
- Do not use on site dry Cleaning machine.
- Children should not climb or jump on the furniture.
- Do not write on furniture without a padded barrier to protect the surface.
- Not for commercial use, For residential use only.



Weight Limitation

220LBS

PARTS LIST

Ax1

Seat

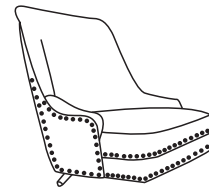

Bx1

Spider base

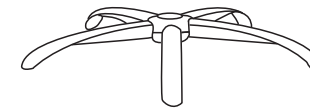

Cx5

Casters



Dx1

Gas lift



Ex1

Bottom machanism

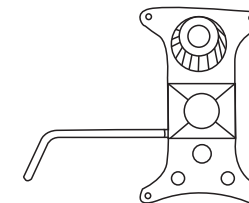

Fx1

Metal base cap



HARDWARE LIST

Gx1

M6
Allen Key

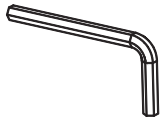

Hx4

M6*20mm
Screw

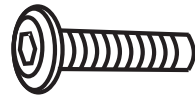

SPARE

Hx1

M6*20mm
Screw

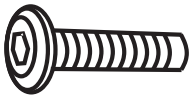

Be sure to check all packing material carefully for small parts, which may have come loose inside the carton during shipment.

ASSEMBLY INSTRUCTIONS

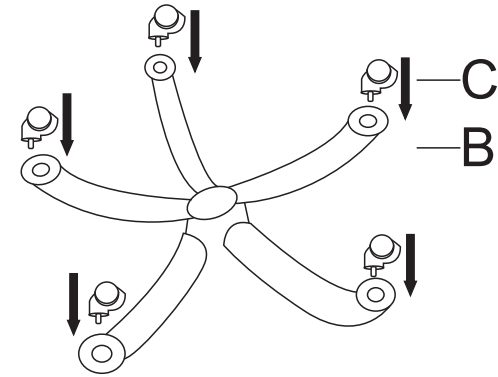

STEP 1: Insert casters C to bottom of the spider base B.

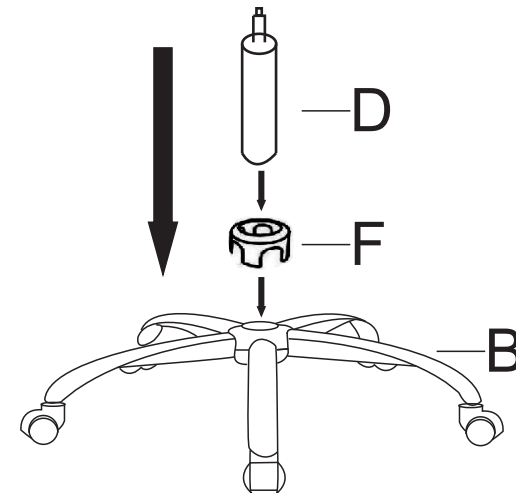

STEP 2: Attach the metal cover F on top of the spider base B then insert the gas lift D to the center hole of the base B.

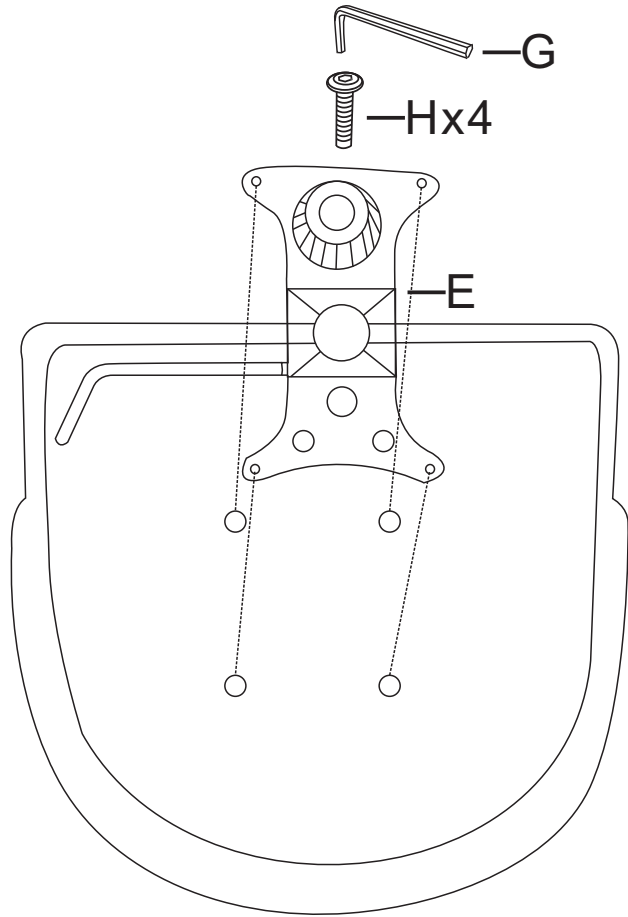

Place the chair seat/back assembly on clean padded surface.

STEP 3 : Use bolt H and allen key G to attach mechanism E to bottom of the seat cushion A, make sure the holes on under seat align with metal plate, then fasten bolts to secure.

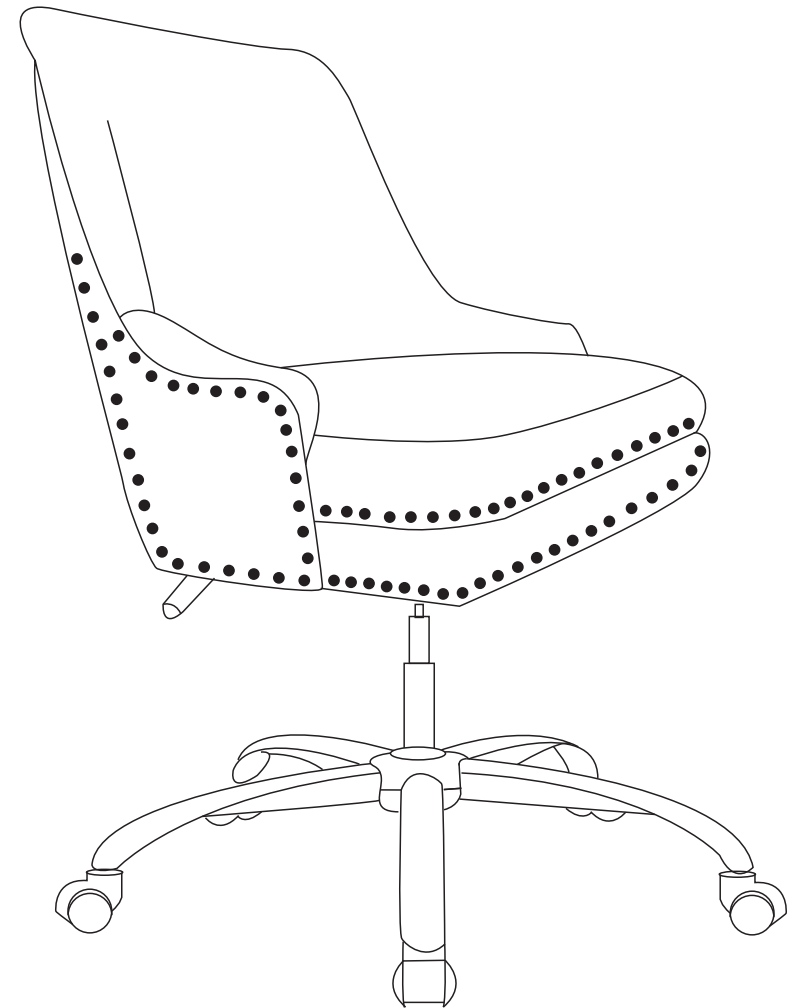

STEP 4 : Assembly completed.