

HULALA

H O M E

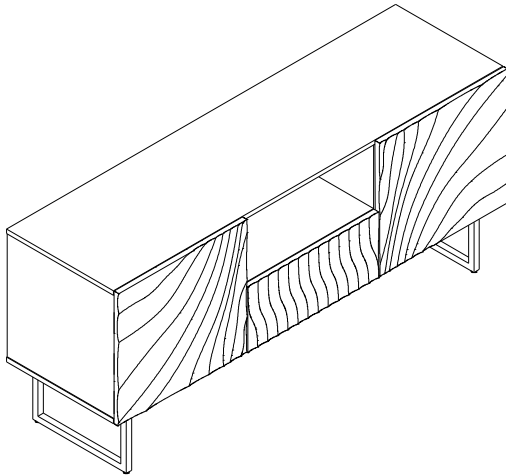

ITEM NO.TVSD0725

NOTE:

This brochure contains IMPORTANT safty info. Please read and keep for future reference.

MAINTAINANCE AND WARNING

- Keep furniture away from heat sources.
- Do not clean furniture with harsh cleaner or polishes. Do not use detergents, Solvents, abrasives, spray packs or leather cleaner. Use non-color mild soap with warm water to clean spills (Mix 1:10 soap to water)
- Do not place furniture under direct sunlight, material will possibly fade over time.
- Do not use on site dry Cleaning machine. Children should not climb or jump on the furniture.
- Do not write on furniture that is not protected by a padded barrier .
- Not for commercial use, only for residential use.





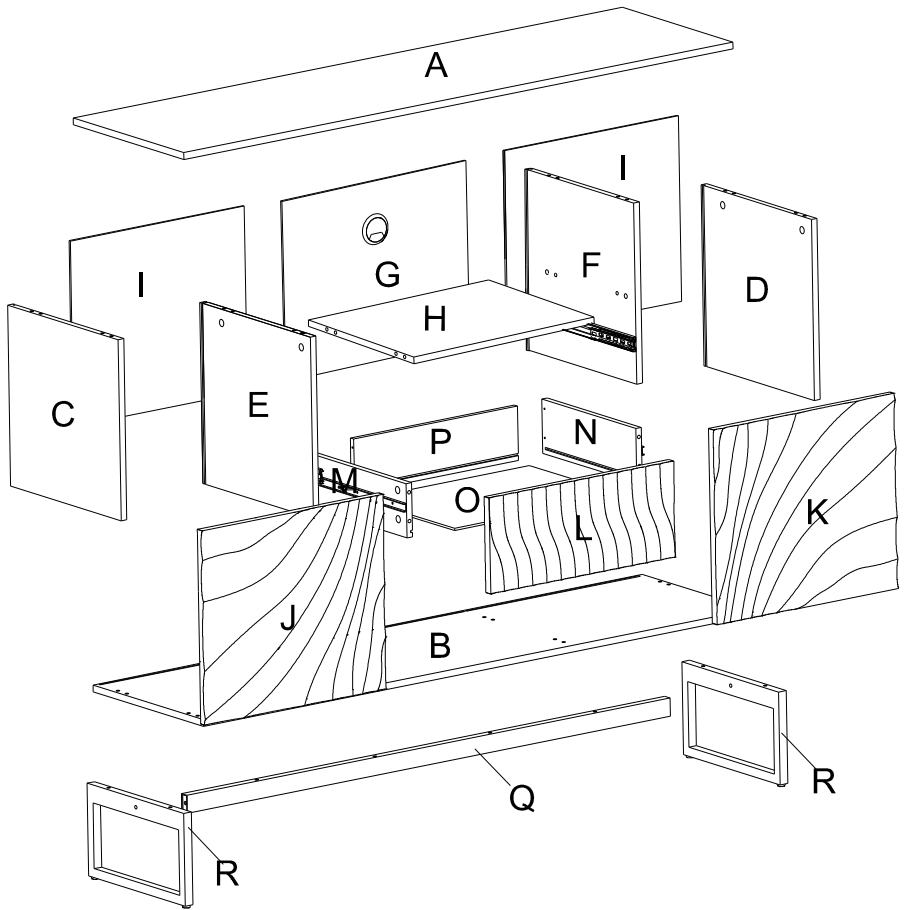

Weight Limitation

80 LBS

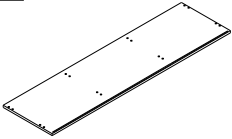
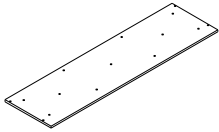
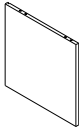
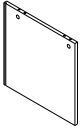
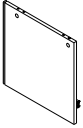
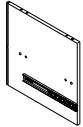
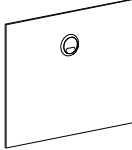
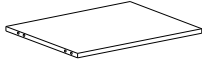
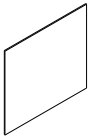
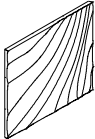
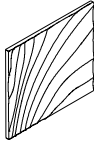

OVERVIEW



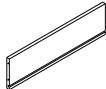
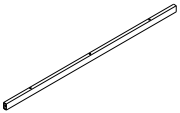
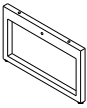



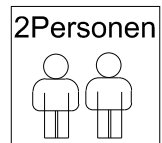

HARDWARE LIST

<p>A</p> 	<p>B</p> 	<p>C</p> 	<p>D</p> 
<p>1 PC</p>	<p>1 PC</p>	<p>1 PC</p>	<p>1 PC</p>
<p>E</p> 	<p>F</p> 	<p>G</p> 	<p>H</p> 
<p>1 PC</p>	<p>1 PC</p>	<p>1 PC</p>	<p>1 PC</p>
<p>I</p> 	<p>J</p> 	<p>K</p> 	<p>L</p> 
<p>2 PCS</p>	<p>1 PC</p>	<p>1 PC</p>	<p>1 PC</p>
<p>M</p> 	<p>N</p> 	<p>O</p> 	<p>P</p> 
<p>1 PC</p>	<p>1 PC</p>	<p>1 PC</p>	<p>1 PC</p>
<p>Q</p> 	<p>R</p> 		
<p>1 PC</p>	<p>2 PCS</p>		







Persons Required For Assembly:



PARTS LIST 1







①	x40	②	x20	③	x16	④	x8	⑤	x16
									
⑥	x8	⑦	x2	⑧	x8				
									

SPARE

①	x4	③	x1	④	x1	⑥	x1	⑦	x1
									
⑧	x1								
									

Be sure to inspect all packing material carefully for small parts, that may have come loose inside the carton during shipment.

PARTS LIST 2

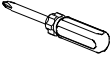
⑨	x4	⑩	x12	⑪	x12	⑫	x4	⑬	x2
									
⑭	x4	⑮	x1	⑯	x1				
									

Be sure to inspect all packing material carefully for small parts, that may have come loose inside the carton during shipment.

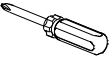

ASSEMBLY INSTRUCTIONS

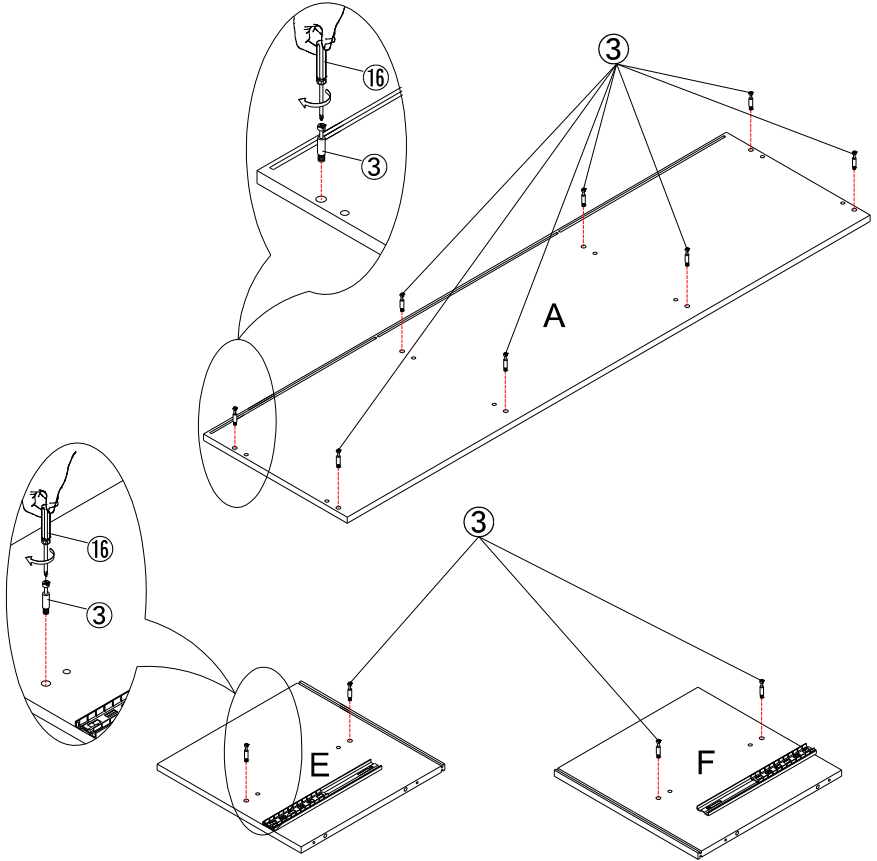
③	x12	⑯	x1
			



STEP1:

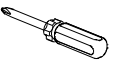

Preparing part A,F,E. align the hole in the part A,F,E, As shown,Put ③ into the hole and tighten with screwdriver ⑯.

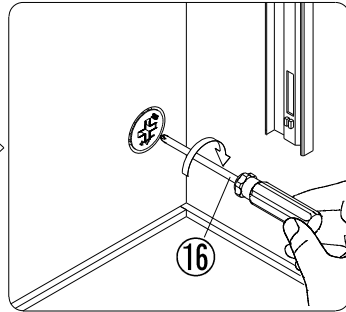
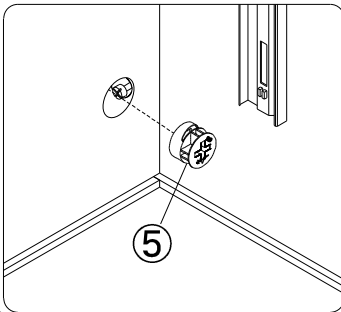
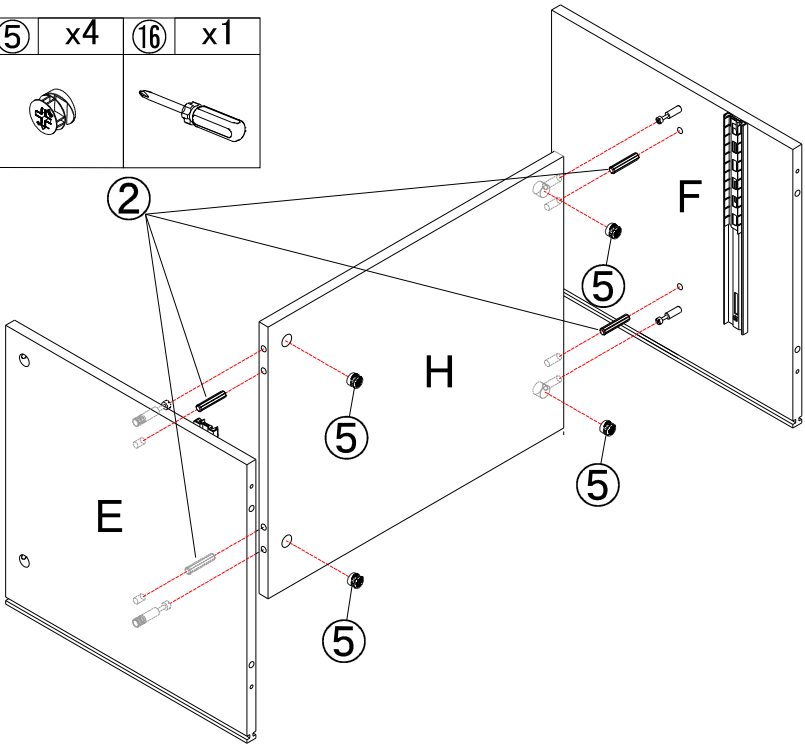
②	x4	⑤	x4	⑬	x1
					



STEP2:

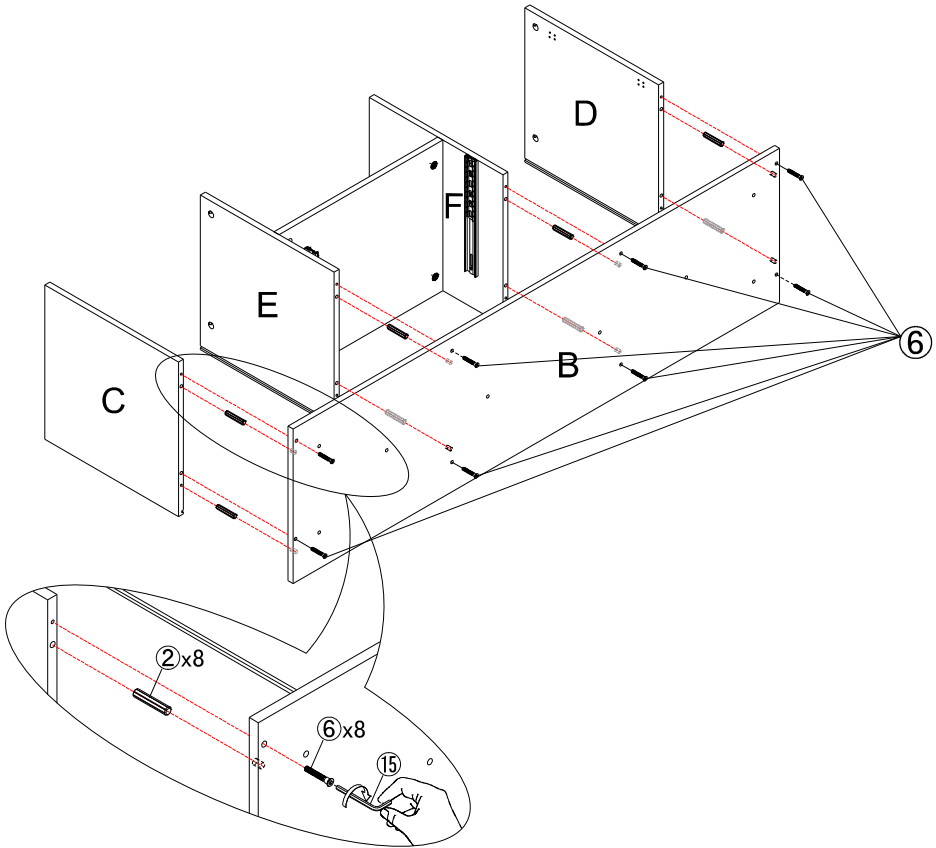

Preparing part H,F,E.align the hole in the part F,E,insert the wooden dowel ② by hand,Connect the part H with part E and F. align the hole in the part H, insert the bolt ③and wooden dowel ② in part E and F into part H.Tighten the nut ⑤ with a screwdriver ⑬.

⑥	x8	⑮	x1	②	x8
					



STEP3:

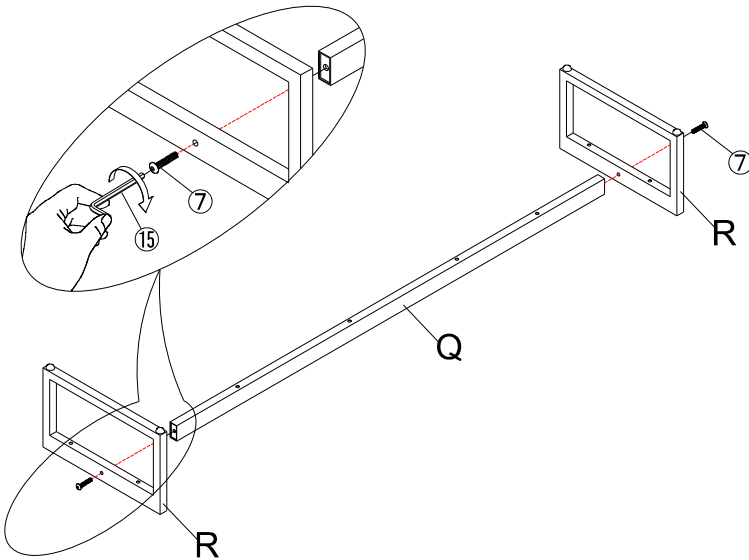

Prepare the parts B.Align the holes in part B and insert bolts ⑥ and wooden dowels ② in parts C,E,D,F.tighten the bolt ⑥ by allen key⑮.

⑦ x2	⑮ x1
	



STEP4:

Prepare leg frames Q and R. Align the hole in the part Q and the hole in the part R, screw and tighten the screw ⑦ by Allenkey ⑮.

⑧	x8	⑮	x1
			

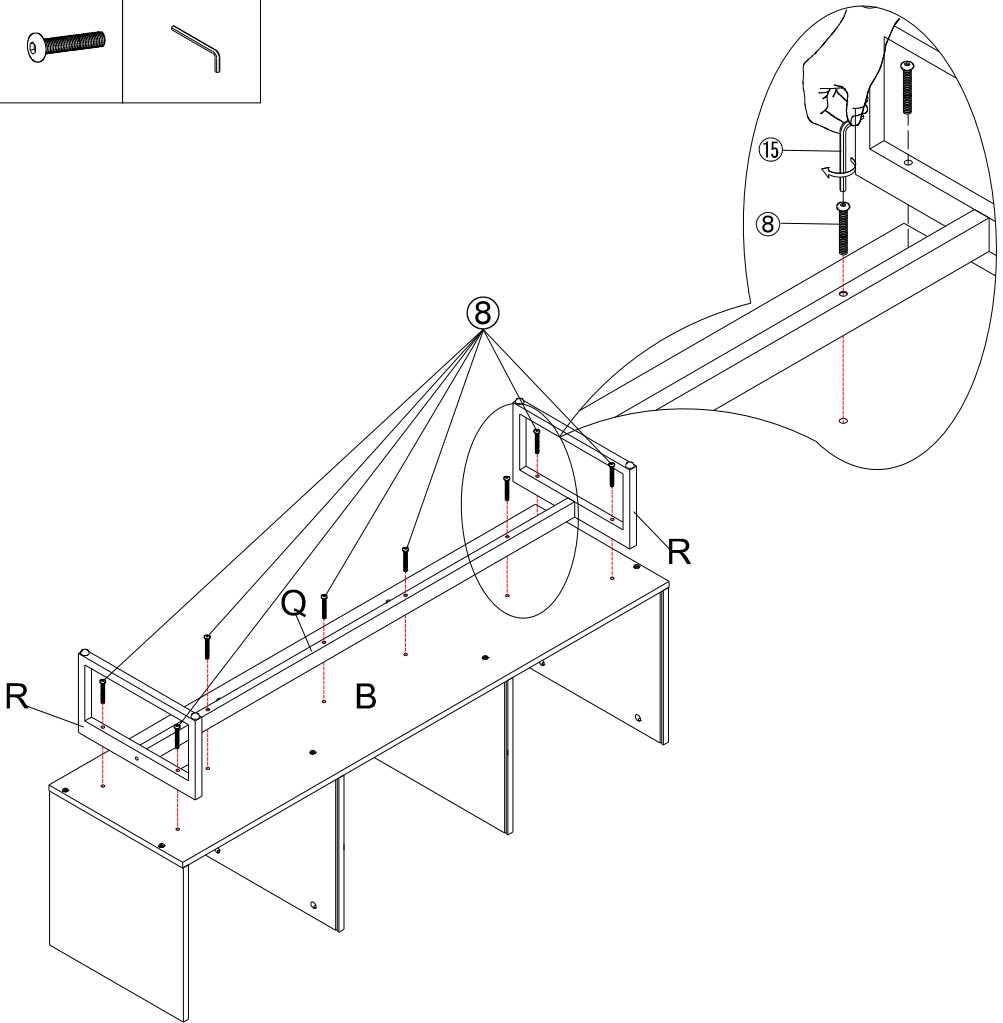

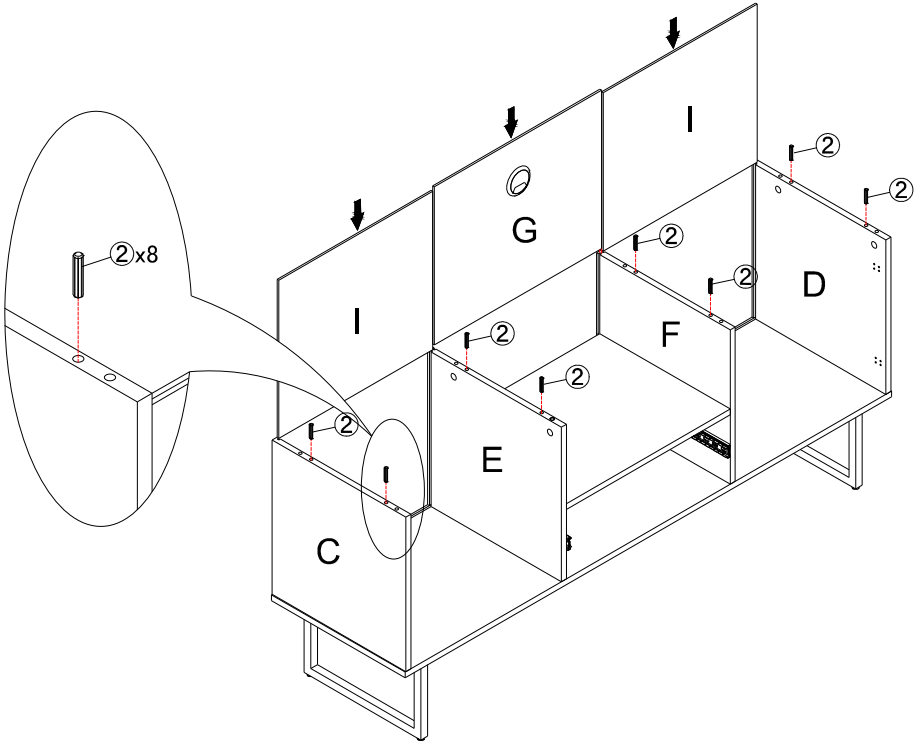
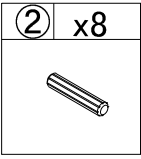

STEP5:

Connect the leg frame to the cabinet. Align the hole in the leg frame part Q and R to the hole in the part B, screw in and tighten the screw ⑧ by Allenkey ⑮.



STEP6:

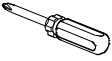

Slide in the part I into the groove in part C, E ,and F,D. make sure they are also in groove in part B.Slide part G into the grooves in E,F. insert wooden dowels ② in parts C,E,D,F.

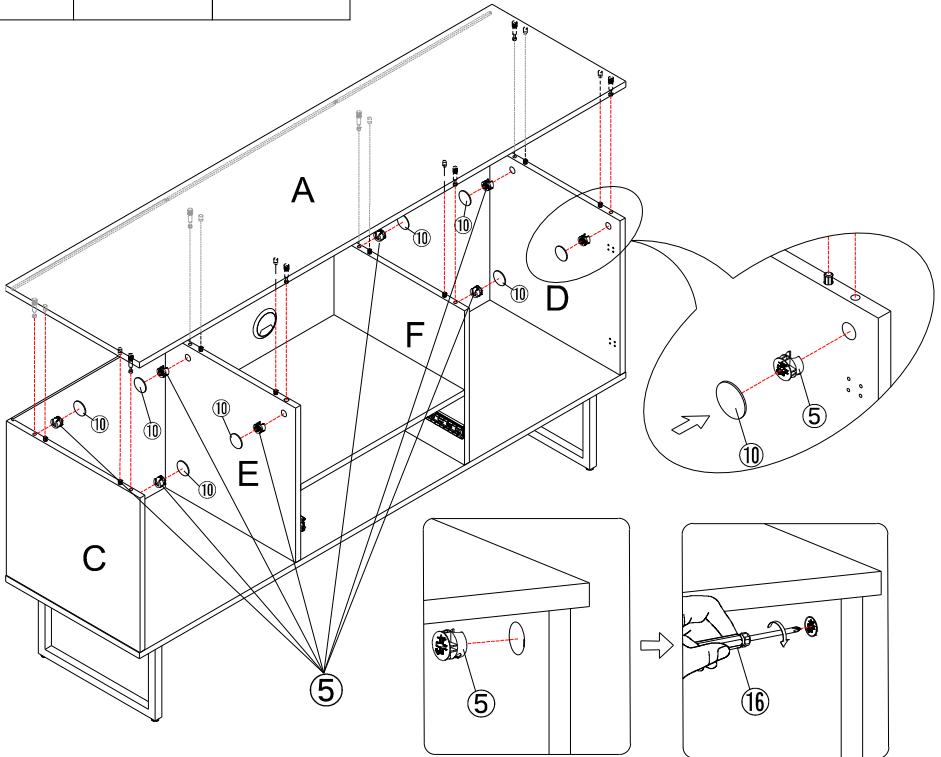
⑤	x8	⑩	x8	⑯	x1
					



STEP7:

Align the hole in the part A and insert the bolt ② and wooden dowel ③ in part C and E and F and D, tighten the nut ⑤ by screwdriver ⑯ and cover ⑩ the screw hole by lid after the installation is finished.

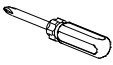
⑨	x4	①	x8	⑯	x1
					

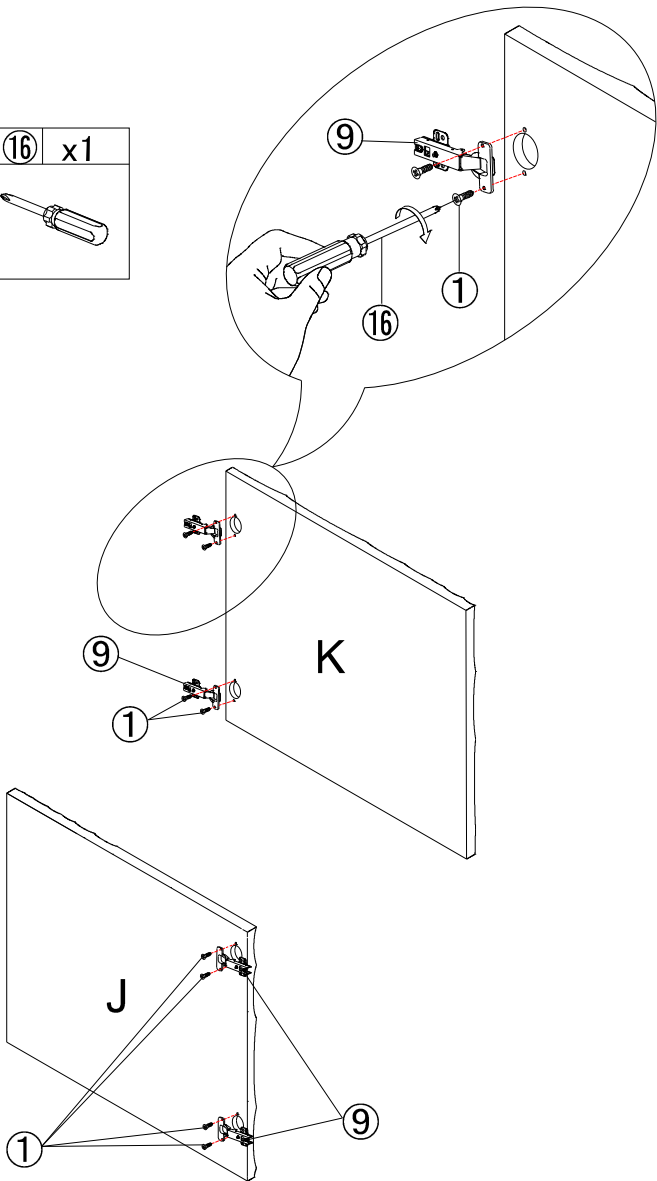

STEP8:

Attach the part ⑨ on the part J and K. align the holes on the ⑨ to the holes in the part J and K, screw in and tighten the screw ① by screwdriver⑯.

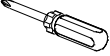
①	x16	⑩	x1
			

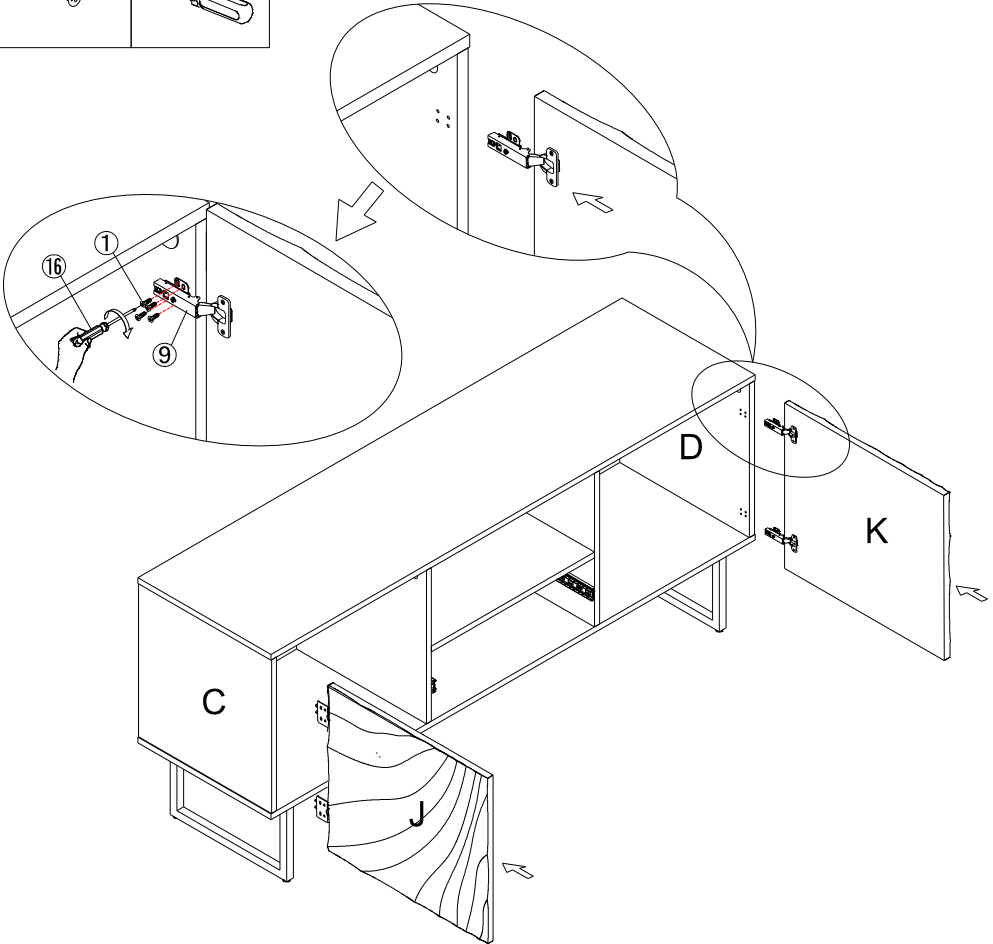

STEP9:

Attach the door on the cabinet. Align the hole in the part ⑨ on the part J and K to the holes in the part C and D, screw in and tighten screw ① by screwdriver ⑩ as the picture show.

Concealed hinges are three-way adjustable:

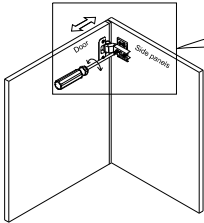

Horizontal
by screw adjustment!

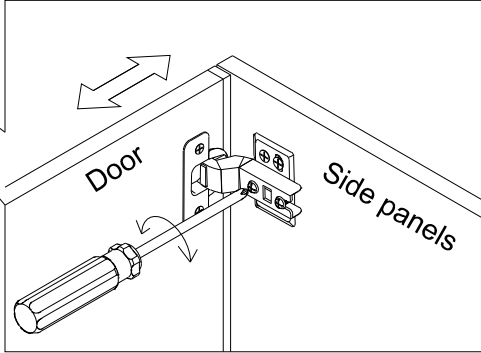

Concealed hinges are three-way adjustable:

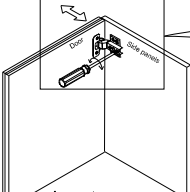

In-and-out
by loosening the hinge arm
mounting screw or via cam
adjustment!

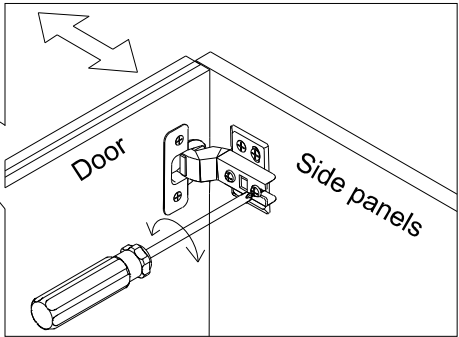



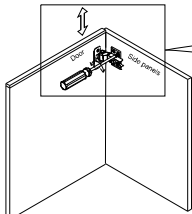

Concealed hinges are three-way adjustable:

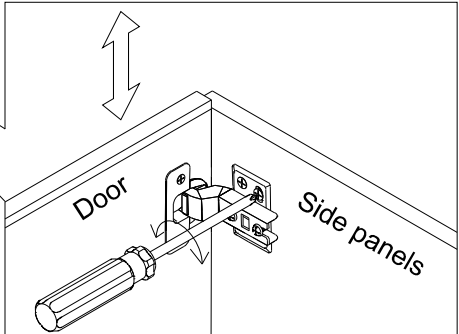

Vertical via slots in
the mounting plate
or via cam adjustment!

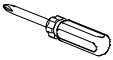

Hinge adjustment method

③ x4	⑤ x4	⑯ x1	⑩ x4
			

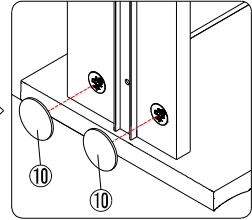
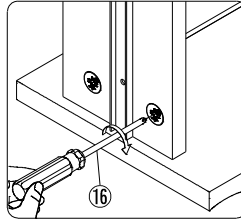
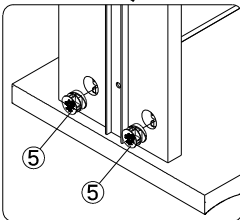
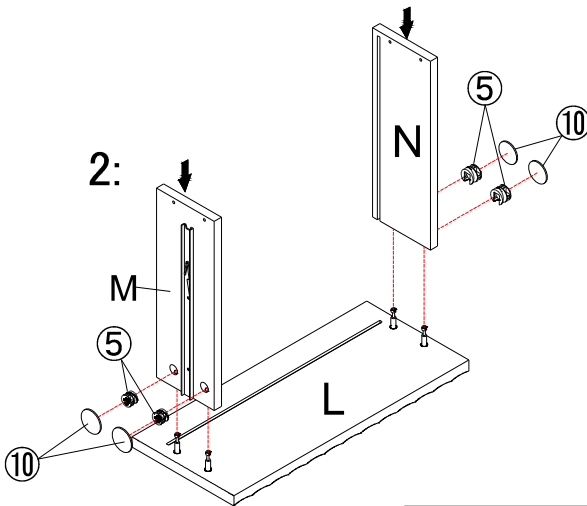
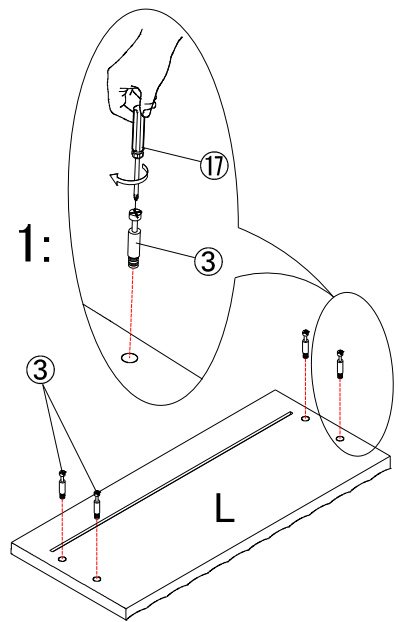

STEP10:

1.Preparing the drawers. Align the holes in the part L, screw bolt ③ into the part L by screwdriver⑯.

2.Align the hole in the part L and insert the bolt ③ in part M and N,tighten the nut ⑤ by screwdriver ⑯ and cover⑩ the screw hole by lid after the installation is finished.

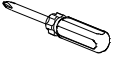
④	x4	⑯	x1
			

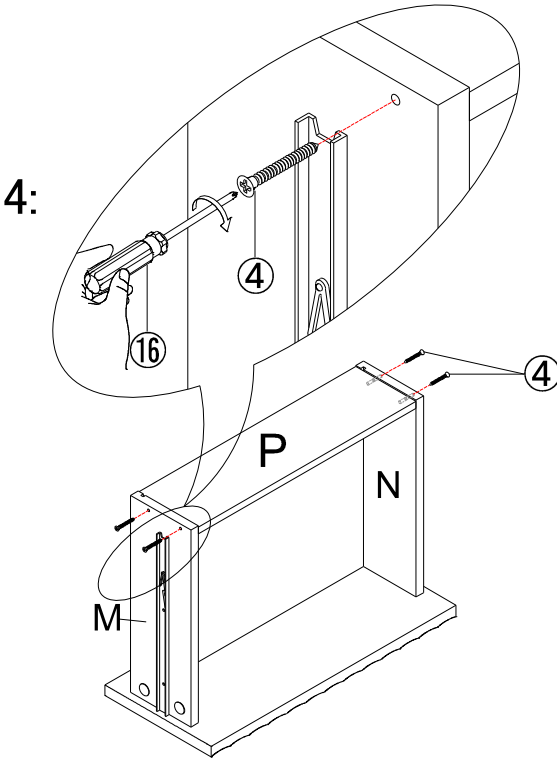
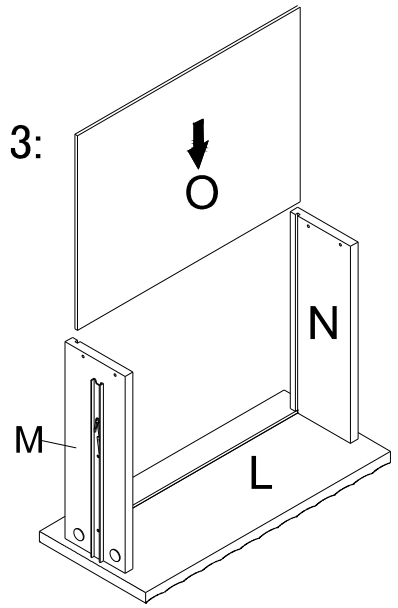

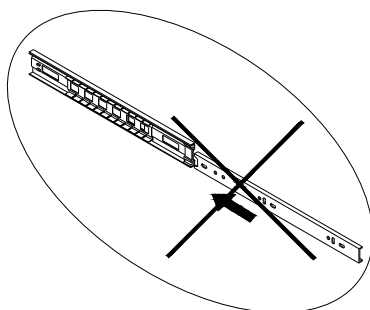
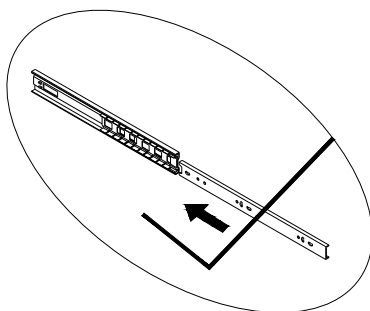
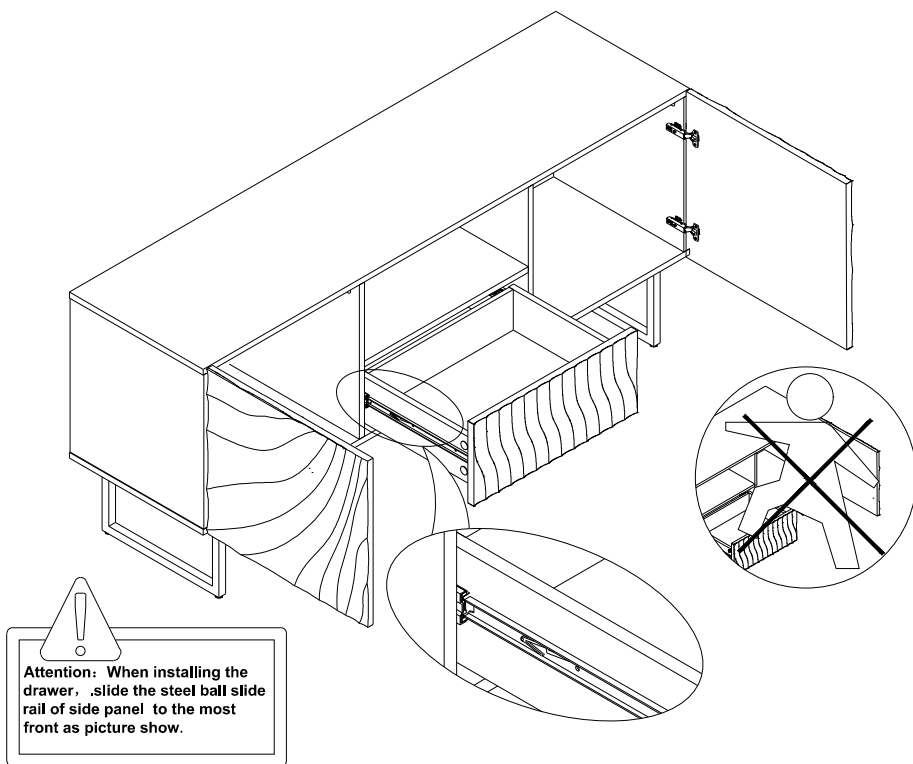

STEP11:

Preparing the drawers. Slide part o into the grooves of M and N. Align the holes in the part P, screw bolt ④ into the part M and N by screwdriver ⑯



STEP12:



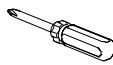

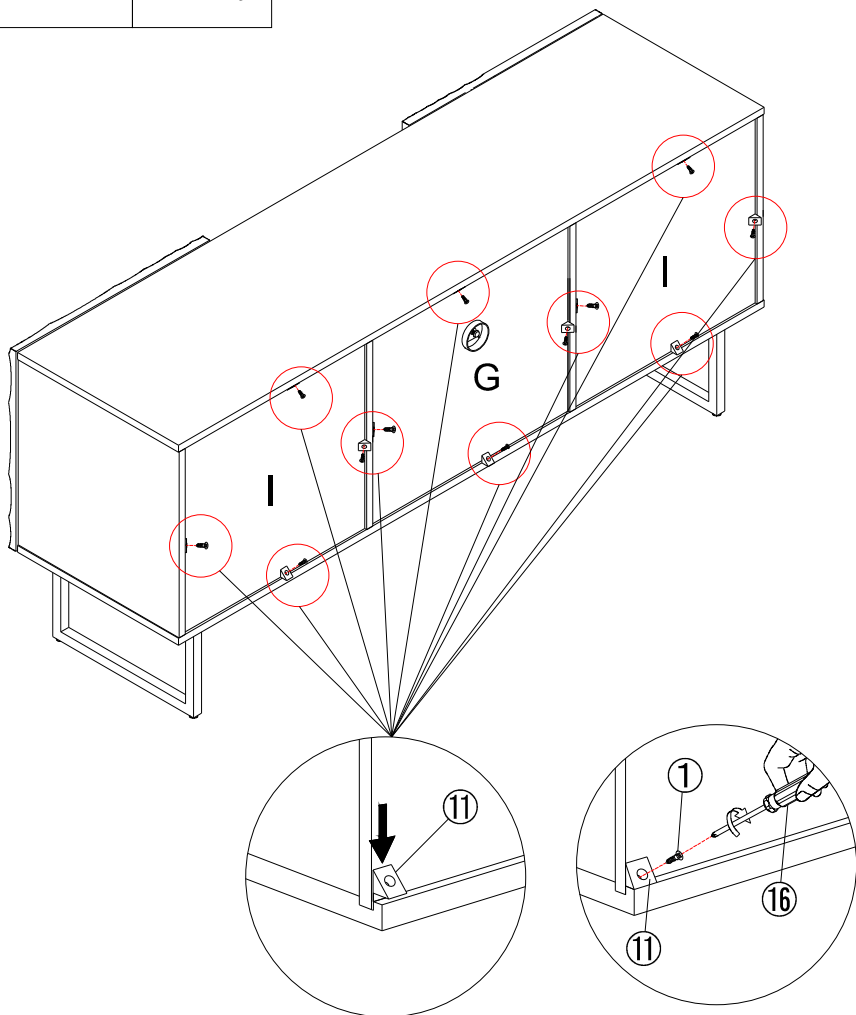
Slide in the drawer into cabinet as the picture show.
You can adjust the distance between drawer and the cabinet .

①	x12	⑪	x12	⑯	x1
					



STEP13:

insert the hardware ⑪ into the part (I)(G) as the picture show,screw in the ① and tighten it with screwdriver ⑯.

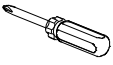
① x4	⑭ x4	⑫ x4	⑬ x2	④ x4	⑯ x1
					

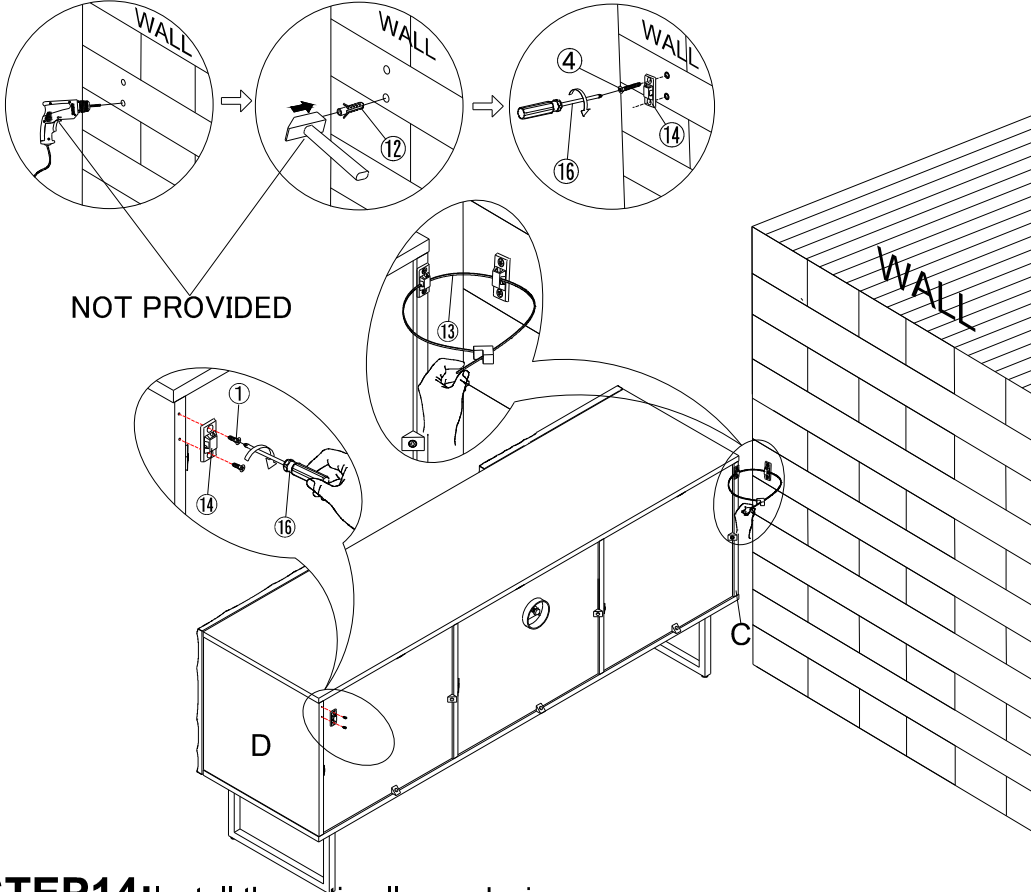

NOT PROVIDED

STEP14: Install the anti-collapse device.

1. Mark the position on the wall, that corresponds to the location of part ⑭ on the side of panel D and C; Drill and insert the expandable screw ⑫ by hammer.
2. Assemble the part ⑭ to the wall. Align the hole in the part ⑭ with the expandable screw ⑫, use screw ④ to attach it and tighten by screwdriver.
3. Let the plastic belt ⑬ pass through the both part ⑭ and pull tightly.

WARRANTY

We strive to offer high-quality products, and we also try our best to satisfy each and every customer that orders from us with product or service as needed. We provide 30 days warranty starting from the time you receive the item. Each customer must provide a record of their order such as the order number, or item receipt for any items that are out of the warranty period you may also still receive replacement parts by purchasing them with our company if they are available.

Are you having difficulty
with assembly? Missing parts?
Please send email with your order No to
customerservice@hulalahome.com
For return, please check the return policy with
the retailer or market place you bought from.

Appreciate your purchasing from us.
Pop up your life by our furniture piece!