

WARRANTY

We strive to offer high-quality products, and we also try our best to satisfy each and every customer that orders from us with product or service as needed. We provide 30 days warranty starting from the time you receive the item. Each customer must provide a record of their order such as the order number, or item receipt for any items that are out of the warranty period you may also still receive replacement parts by purchasing them with our company if they are available.

**Are you having difficulty
with assembly? Missing parts?**

**PLEASE DON' T RETURN THE ITEM TO
RETAILER**

For help call or email with your order No.

Customer service:

888-214-6610

Open Monday through Friday

9:00AM-5:00PM CST

Email:

customerservice@hulalahome.com

24h

HULALA

H O M E

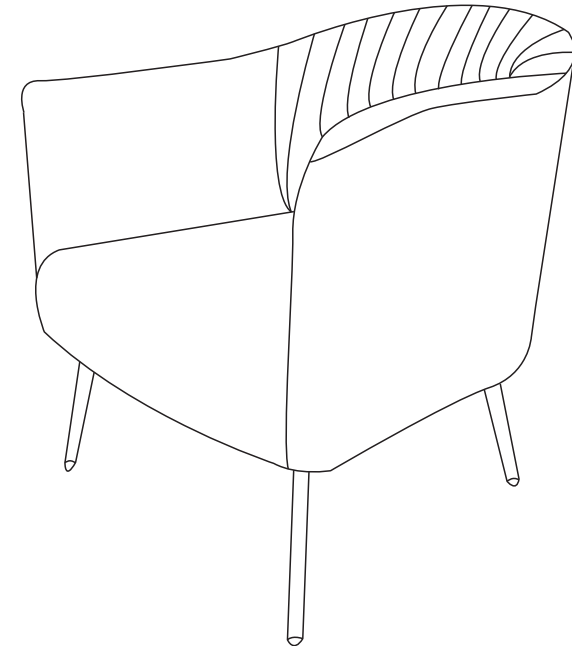

ITEM NO.CHM0118

NOTE:

This brochure contains IMPORTANT safty info. Please read and keep for future reference.

MAINTENANCE AND WARNING

- Keep furniture away from heat.
- Do not clean furniture with harsh cleansers or polish. Do not use detergents, Solvents, abrasives, spray packs or leather cleaner. Use non-color mild soap with warm water clean spills(Mix 1:10 soap to water)
- Do not place furniture under direct sunlight, material will possibly fade over time.
- Do not use on site dry Cleaning machine.
- Children should not climb or jump on the furniture.
- Do not write on furniture without a padded barrier to protect the surface.
- To obtain the longest lifespan of your outdoor products, avoid exposure to rain or snow, and direct sunshine for long time. Whenever possible cover the product and/or place under patio or awnings.
- Not for commercial use, For residential use only.



Weight Limitation

250LBS

PARTS LIST

Ax1

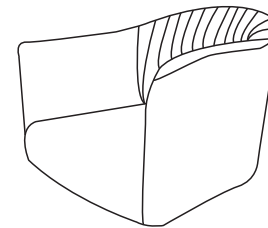

Bx4

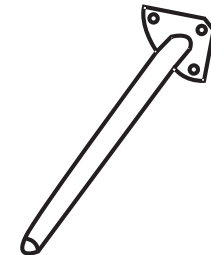

Estimated Duration Of Assembly

5-10 MINUTES

HARDWARE LIST

Cx12

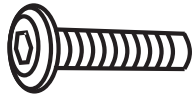

Dx1

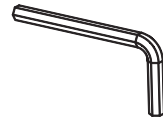

SPARE

Cx1

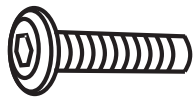

Hx1



Be sure to check all packing material carefully for small parts, which may have come loose inside the carton during shipment.

ASSEMBLY INSTRUCTIONS

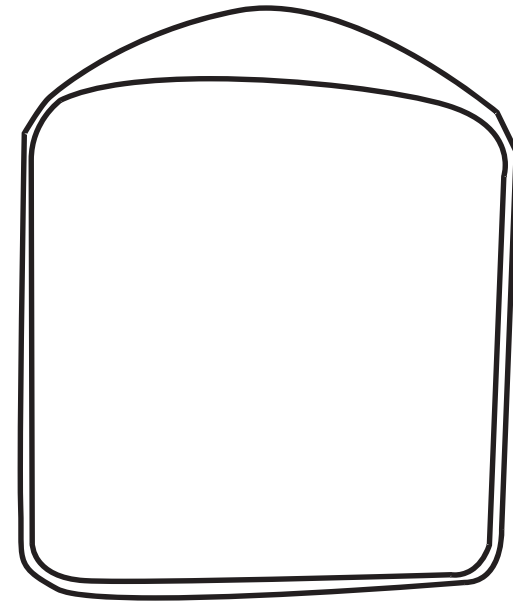

STEP 1: Place the Chair Back A on a clean padded surface.

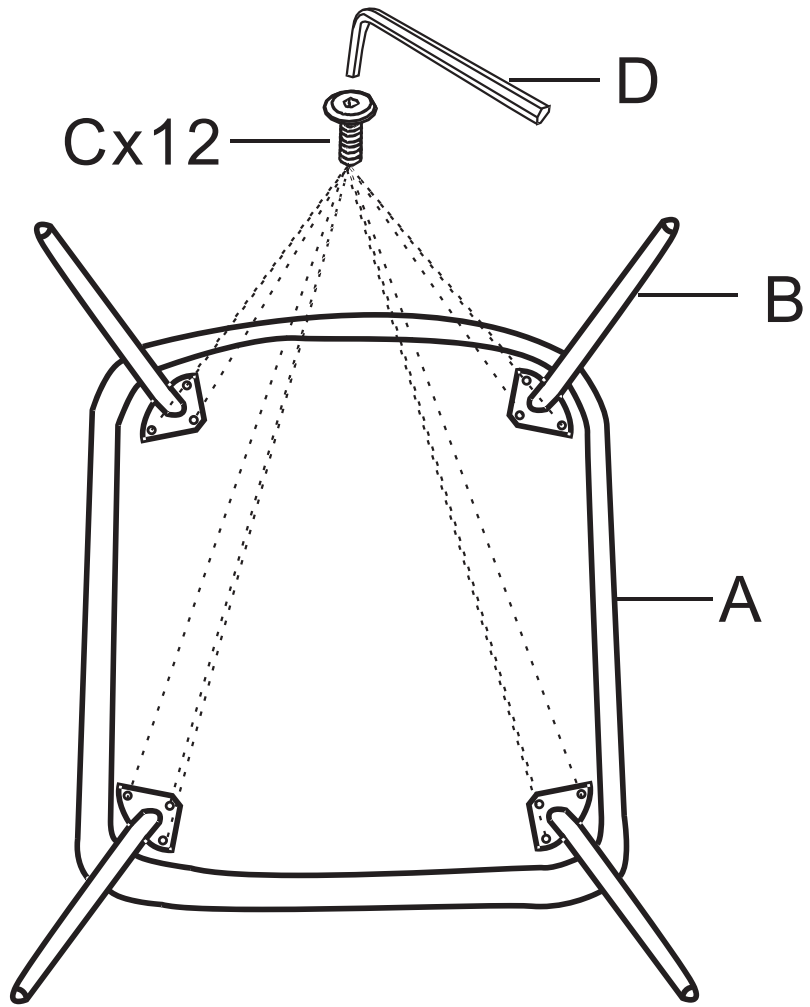

STEP 2 :Use bolt C, allen key D to connect the metal leg B to bottom of the seat cushion A, make sure all holes align, fasten all bolts to secure.



For velvet:With help of adult partner, Iron the fabric cover to stretch the wrinkles and dent mark with steam iron while necessary.please separate with a towel before ironing..

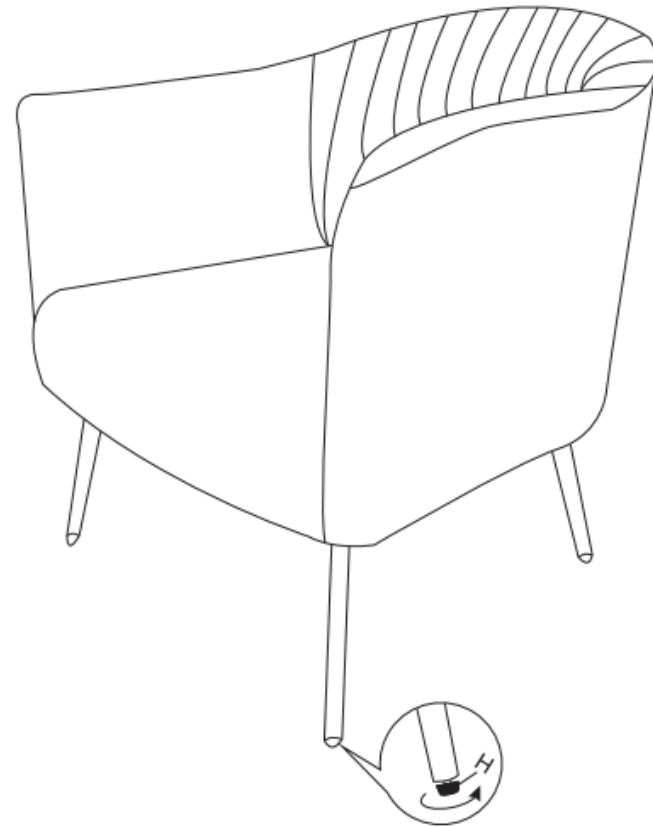

Adjust levelers under legs to set the seat level.

STEP 3 :Assembly completed.